

Test Report

(EN 50155 & EN 50121-3-2)

Report No.: CEBDBO-WTW-P23030402-1

Test Model: EAC-3000

Series Model: EAC-3000 Series, EAC-3XXXXXXXXXXXXXXXXX ("X" can be 0-9, A-Z, - or blank for marketing purpose)

Received Date: 2023/3/13

Test Date: 2023/3/14 ~ 2023/3/21

Issued Date: 2023/4/10

Applicant: Vecow Co., Ltd.

Address: 3F., No.10, Jiankang Rd., Zhonghe Dist., New Taipei City 23586, Taiwan

Issued By: Bureau Veritas Consumer Products Services (H.K.) Ltd., Taoyuan Branch
Lin Kou Laboratories

Lab Address: No. 47-2, 14th Ling, Chia Pau Vil., Lin Kou Dist., New Taipei City, Taiwan



This report is governed by, and incorporates by reference, the Conditions of Testing as posted at the date of issuance of this report at <http://www.bureauveritas.com/home/about-us/our-business/cps/about-us/terms-conditions/> and is intended for your exclusive use. Any copying or replication of this report to or for any other person or entity, or use of our name or trademark, is permitted only with our prior written permission. This report sets forth our findings solely with respect to the test samples identified herein. The results set forth in this report are not indicative or representative of the quality or characteristics of the lot from which a test sample was taken or any similar or identical product unless specifically and expressly noted. Our report includes all of the tests requested by you and the results thereof based upon the information that you provided to us. Measurement uncertainty is only provided upon request for accredited tests. Statements of conformity are based on simple acceptance criteria without taking measurement uncertainty into account, unless otherwise requested in writing. You have 60 days from date of issuance of this report to notify us of any material error or omission caused by our negligence or if you require measurement uncertainty; provided, however, that such notice shall be in writing and shall specifically address the issue you wish to raise. A failure to raise such issue within the prescribed time shall constitute your unqualified acceptance of the completeness of this report, the tests conducted and the correctness of the report contents.

Table of Contents

Release Control Record	4
1 Certificate of Conformity	5
2 Summary of Test Results	6
2.1 Performance Criteria	9
2.2 Measurement Uncertainty	9
2.3 Modification Record.....	9
3 General Information	10
3.1 Description of EUT	10
3.2 Features of EUT	10
3.3 Operating Modes of EUT and Determination of Worst Case Operating Mode	11
3.4 Test Program Used and Operation Descriptions.....	11
3.5 Primary Clock Frequencies of Internal Source	11
4 Configuration and Connections with EUT	12
4.1 Connection Diagram of EUT and Peripheral Devices.....	12
4.2 Configuration of Peripheral Devices and Cable Connections	14
5 Conducted Disturbance at Auxiliary a.c. or d.c. Power Ports	18
5.1 Limits	18
5.2 Test Instruments	18
5.3 Test Arrangement	19
5.4 Test Results	20
6 Radiated Disturbance up to 1 GHz	22
6.1 Limits	22
6.2 Test Instruments	22
6.3 Test Arrangement	23
6.4 Test Results	24
7 Radiated Disturbance above 1 GHz	26
7.1 Limits	26
7.2 Test Instruments	27
7.3 Test Arrangement	28
7.4 Test Results	29
8 Harmonics Current Measurement	31
8.1 Limits	31
8.2 Classification of Equipment.....	31
8.3 Test Instruments	31
8.4 Test Arrangement	32
8.5 Test Results	33
9 Voltage Fluctuations and Flicker Measurement	34
9.1 Limits	34
9.2 Test Instruments	34
9.3 Test Arrangement	34
9.4 Test Results	35
10 Electrostatic Discharge Immunity Test (ESD)	36
10.1 Test Specification.....	36
10.2 Test Instruments	36
10.3 Test Arrangement	37
10.4 Test Results	38

11	Radio-frequency Electromagnetic Field Immunity Test (RS)	42
11.1	Test Specification.....	42
11.2	Test Instruments	42
11.3	Test Arrangement	44
11.4	Test Results	44
12	Electrical Fast Transient/Burst Immunity Test (EFT)	45
12.1	Test Specification.....	45
12.2	Test Instruments	45
12.3	Test Arrangement	46
12.4	Test Results	47
13	Surge Immunity Test	48
13.1	Test Specification.....	48
13.2	Test Instruments	48
13.3	Test Arrangement	49
13.4	Test Results	49
14	Immunity to Conducted Disturbances Induced by RF Fields (CS)	50
14.1	Test Specification.....	50
14.2	Test Instruments	50
14.3	Test Arrangement	52
14.4	Test Results	53
15	Pictures of Test Arrangements	54
15.1	Conducted Disturbance at Auxiliary a.c. or d.c. power ports	54
15.2	Radiated Disturbance up to 1 GHz	55
15.3	Radiated Disturbance above 1 GHz.....	56
15.4	Harmonics Current, Voltage Fluctuations and Flicker Measurement.....	57
15.5	Electrostatic Discharge Immunity Test (ESD)	57
15.6	Radio-frequency Electromagnetic Field Immunity Test (RS)	58
15.7	Fast Transients (EFT).....	59
15.8	Surge	61
15.9	Radio-frequency common mode (CS).....	62
Appendix – Information of the Testing Laboratories		64

Release Control Record

Issue No.	Description	Date Issued
CEBDBO-WTW-P23030402-1	Original release.	2023/4/10

1 Certificate of Conformity

Product: Edge AI Computing System
Brand: Vecow
Test Model: EAC-3000
Series Model: EAC-3000 Series, EAC-3XXXXXXXXXXXXXXXXX ("X" can be 0-9, A-Z, - or blank for marketing purpose)
Sample Status: Engineering sample
Applicant: Vecow Co., Ltd.
Test Date: 2023/3/14 ~ 2023/3/21
Standards: **EN 50155:2017, Clause 13.4.8**
EN 61000-3-2:2014, Class A
EN IEC 61000-3-2:2019 +A1:2021, Class A
EN 61000-3-3:2013 +A2:2021
EN 50121-1:2017
EN 50121-3-2:2016
EN 61000-4-2:2009
EN 61000-4-3:2006 +A1:2008 +A2:2010
EN IEC 61000-4-3:2020
EN 61000-4-4:2012
EN 61000-4-5:2014 +A1:2017
EN 61000-4-6:2014 +AC:2015

The above equipment has been tested by **Bureau Veritas Consumer Products Services (H.K.) Ltd., Taoyuan Branch**, and found compliance with the requirement of the above standards. The test record, data evaluation & Equipment Under Test (EUT) configurations represented herein are true and accurate accounts of the measurements of the sample's EMC characteristics under the conditions specified in this report.

Prepared by : Albee Chu , **Date:** 2023/4/10
Albee Chu / Specialist

Approved by : Jim Hsiang , **Date:** 2023/4/10
Jim Hsiang / Associate Technical Manager

2 Summary of Test Results

EN 50121-3-2:2016, Emission requirements, EN 50155:2017, Clause 13.4.8			
Port	Test Item / specifications	Result/Remarks	Verdict
Auxiliary a.c. or d.c. power ports - Auxiliary supply sinusoidal a.c. or d.c.	Conducted disturbance 150 kHz- 500 kHz: 99 dB μ V quasi-peak 500 kHz- 30 MHz: 93 dB μ V quasi-peak	Minimum passing margin is -48.51 dB at 0.15012 MHz	Pass
Auxiliary a.c. or d.c. power ports – AC power outlet port for public use	Conducted disturbance 50 Hz- 2 kHz: THD <8% (THD: total harmonic distortion)	Test not applicable because the port does not exist.	N/A
Battery referenced ports - Battery power supply	Conducted disturbance 150 kHz- 500 kHz: 99 dB μ V quasi-peak 500 kHz- 30 MHz: 93 dB μ V quasi-peak	Test not applicable because the port does not exist.	N/A
Enclosure	Radiated disturbance 30 MHz- 230 MHz: 40 dB μ V/m quasi-peak 230 MHz -1 GHz: 47 dB μ V/m quasi-peak	Minimum passing margin is -5.27 dB at 125.01 MHz	Pass
Enclosure	Radiated disturbance 1 GHz- 3 GHz: 76 dB μ V/m peak 56 dB μ V/m average 3 GHz - 6 GHz: 80 dB μ V/m peak 60 dB μ V/m average	Minimum passing margin is -7.97 dB at 2186.90 MHz	Pass

Emission requirements			
Standard	Test Item / specifications	Result/Remarks	Verdict
EN 61000-3-2:2014 EN IEC 61000-3-2:2019+A1:2021	Harmonic current emissions	Meets Class A Limit	Pass
EN 61000-3-3:2013+A2:2021	Voltage fluctuations and flicker	$P_{st} \leq 1.0$ $d_{max} \leq 4\%$ $P_{it} \leq 0.65$ $d_c \leq 3.3\%$ $T_{max} \leq 500ms$	Pass

EN 50121-3-2:2016, Immunity requirements,
EN 50155:2017, Clause 13.4.8

Table Clause	Basic standard	Port	Test Item / specifications	Result/Remarks	Verdict
3.1	EN 61000-4-6:2014 +AC:2015	Battery referenced ports (except at the output of energy sources), Auxiliary a.c. power input ports (rated voltage ≤ 400 Vrms)	Radio-frequency common mode (CS) 80% AM (1kHz) 0.15-80 MHz, 10V Performance Criterion A	Performance Criterion A	Pass
3.2	EN 61000-4-4:2012	Battery referenced ports (except at the output of energy sources), Auxiliary a.c. power input ports (rated voltage ≤ 400 Vrms)	Fast Transients (EFT) 5/50 (tr/tw) ns, 5kHz ± 2 kV Performance Criterion A	Performance Criterion A	Pass
3.3	EN 61000-4-5:2014 +A1:2017	Battery referenced ports (except at the output of energy sources), Auxiliary a.c. power input ports (rated voltage ≤ 400 Vrms)	Surges 1.2/50 (8/20) (T _i /T _d) μ s Line to ground: ± 2 kV 42 Ω , 0.5 μ F Line to line: ± 1 kV 42 Ω , 0.5 μ F Performance Criterion B	Performance Criterion B	Pass
4.1	EN 61000-4-6:2014 +AC:2015	Signal & communication, process measurement & control ports	Radio-frequency common mode (CS) 80% AM (1kHz) 0.15-80 MHz, 10V Performance Criterion A	Performance Criterion A	Pass
4.2	EN 61000-4-4:2012	Signal & communication, process measurement & control ports	Fast Transients (EFT) 5/50 (tr/tw) ns, 5kHz ± 2 kV, Capacitive clamp Performance Criterion A	Performance Criterion A	Pass
5.1	EN 61000-4-3:2006 +A1:2008 +A2:2010/ EN IEC 61000-4-3:2020	Enclosure ports	Radio-frequency electromagnetic field amplitude modulated (RS) ¹ , 80% AM (1kHz) 80-800 MHz, 20V/m Performance Criterion A	Performance Criterion A	Pass
5.2	EN 61000-4-3:2006 +A1:2008 +A2:2010/ EN IEC 61000-4-3:2020	Enclosure ports	Radio-frequency electromagnetic field from digital mobile telephones (RS) ² , 80% AM (1kHz) 800-1000 MHz, 20V/m 1400-2000 MHz, 10V/m 2000-2700 MHz, 5V/m 5100-6000 MHz, 3V/m Performance Criterion A	Performance Criterion A	Pass

EN 50121-3-2:2016, Immunity requirements,
EN 50155:2017, Clause 13.4.8

Table Clause	Basic standard	Port	Test Item / specifications	Result/Remarks	Verdict
5.3	EN 61000-4-2:2009	Enclosure ports	Electrostatic Discharges (ESD) ±6kV Contact discharge ±8kV Air discharge Performance Criterion B	Performance Criterion B	Pass

Note 1: This limit applies to equipment mounted in the passenger compartments, drivers cab or external to the rolling stock (roof, underframe). For equipment mounted in all other areas a severity level of 10 V/m may be used.

Note 2: For large apparatus (e.g. traction drives, auxiliary converters) it is often not practical to perform the immunity test to radiated electromagnetic fields on the complete unit. In such cases the manufacturer should test susceptible sub-systems (e.g. control electronics). The test report should justify the selection or not of sub-systems and any assumptions made (e.g. reduction of field due to case shielding).

Note:

1. There is no deviation to the applied test methods and requirements covered by the scope of this report.
2. The above EN basic standards are applied with latest version if customer has no special requirement.
3. Determining compliance based on the results of the compliance measurement, not taking into account measurement instrumentation uncertainty.
4. N/A: Not Applicable

2.1 Performance Criteria

General Performance Criteria

The general performance criteria apply for those ports for which no specific performance criteria are defined (e.g. auxiliary ports) in the report.

Performance criterion A: The apparatus shall continue to operate as intended during and after the test. No degradation of performance or loss of function is allowed below a performance level specified by the manufacturer, when the apparatus is used as intended. The performance level may be replaced by a permissible loss of performance. If the minimum performance level or the permissible performance loss is not specified by the manufacturer, either of these may be derived from the product description and documentation, and from what the user may reasonably expect from the apparatus if used as intended..

Performance criterion B: The apparatus shall continue to operate as intended after the test. No degradation of performance or loss of function is allowed below a performance level specified by the manufacturer, when the apparatus is used as intended. The performance level may be replaced by a permissible loss of performance. During the test, degradation of performance is however allowed. No change of actual operating state or stored data is allowed. If the minimum performance level or the permissible performance loss is not specified by the manufacturer, either of these may be derived from the product description and documentation, and from what the user may reasonably expect from the apparatus if used as intended.

Performance criterion C: Temporary loss of function is allowed, provided the function is self-recoverable or can be restored by the operation of the controls.

2.2 Measurement Uncertainty

Where relevant, the following measurement uncertainty levels have been estimated for tests performed on the EUT as specified in CISPR 16-4-2:

Measurement	Expanded Uncertainty (k=2) (\pm)	Maximum allowable uncertainty (\pm)
Conducted disturbance at mains port using AMN, 150kHz ~ 30MHz	3.00 dB	3.4 dB (U_{CISPR})
Radiated disturbance, 30MHz ~ 1GHz	3m : 5.72 dB 10m : 4.38 dB	6.3 dB (U_{CISPR})
Radiated disturbance, 1GHz ~ 6GHz	4.42 dB	5.2 dB (U_{CISPR})

The other instruments specified are routine verified to remain within the calibrated levels, no measurement uncertainty is required to be calculated.

2.3 Modification Record

There were no modifications required for compliance.

3 General Information

3.1 Description of EUT

Product	Edge AI Computing System
Brand	Vecow
Test Model	EAC-3000
Series Model	EAC-3000 Series, EAC-3XXXXXXXXXXXXXXXXX ("X" can be 0-9, A-Z, - or blank for marketing purpose)
Sample Status	Engineering sample
Operating Software	Ubuntu 18.04 LTS
Power Supply Rating	DC from Adapter
Accessory Device	N/A
Data Cable Supplied	N/A

Note:

The following adapter was provided by client for test.

Brand	Model	Specification
LITEON	PA-1181-28	AC Input : 100-240V, 2.34A, 50-60Hz DC Output : 24V, 7.5A, 180W DC Output Cable: 1.6m with two ferrite cores

3.2 Features of EUT

- The tests reported herein were performed according to the method specified by Vecow Co., Ltd., for detailed feature description, please refer to the manufacturer's specifications or user's manual.
- The EUT configured with the following key components:

System

CPU	8-core NVIDIA Carmel ARM [®] v8.2 64-bit CPU
GPU	NVIDIA Volta architecture with 512 NVIDIA [®] CUDA [®] cores and 64 Tensor cores
DL Accelerator	2x NVDLA Engines
Memory	1 LPDDR4x DRAM, Up to 64GB
OS	Linux Ubuntu 18.04 with JetPack

3.3 Operating Modes of EUT and Determination of Worst Case Operating Mode

1. The EUT has been pre-tested under following test modes.

Test Condition	
Mode	Radiated Emissions up to 1 GHz
1	Full system + Input Power(230 Vac, 50 Hz)
2	Full system + Input Power(120 Vac, 60 Hz)
Note: The worst case is that mode 1 is shown in bold.	

2. Test modes are presented in the report as below.

Test Condition	
Mode	Conducted Emissions from Power Ports
A	Full system + Input Power(230 Vac, 50 Hz)
Mode	Radiated Emissions up to 1 GHz
A	Full system + Input Power(230 Vac, 50 Hz)
Mode	Radiated Emissions above 1 GHz
A	Full system + Input Power(230 Vac, 50 Hz)

3.4 Test Program Used and Operation Descriptions

Emission tests (Harmonics & Flicker excluded):

- Turned on the power of all equipment.
- EUT ran a test program to enable all functions.
- EUT read and wrote messages to/ from internal storage drives, and external storage drives.
- EUT sent "H" messages to monitor. Then the displayed messages on their screens simultaneously.
- EUT sent and received messages to/ from Laptop (kept in a remote area) via STP cable.
- EUT received video image signal from camera.
- Steps c-f were repeated.

Harmonics & Flicker & Immunity tests:

- Turned on the power of all equipment.
- EUT ran a test program to enable all functions.
- EUT read and wrote messages to/ from internal storage drives, and external storage drives.
- EUT sent "color bars with moving element" messages to monitor. Then the monitor displayed messages on their screens simultaneously.
- EUT sent and received messages to/ from Laptop(kept in a remote area) via STP cable.
- EUT received video image signal from camera and send it to monitor, then the monitor displayed it on its screen.
- Steps c-f were repeated.

3.5 Primary Clock Frequencies of Internal Source

The highest frequency generated or used within the EUT or on which the EUT operates or tunes is 2.26GHz, provided by Vecow Co., Ltd., for detailed internal source, please refer to the manufacturer's specifications.

4 Configuration and Connections with EUT

4.1 Connection Diagram of EUT and Peripheral Devices

Emission tests (Harmonics & Flicker excluded):

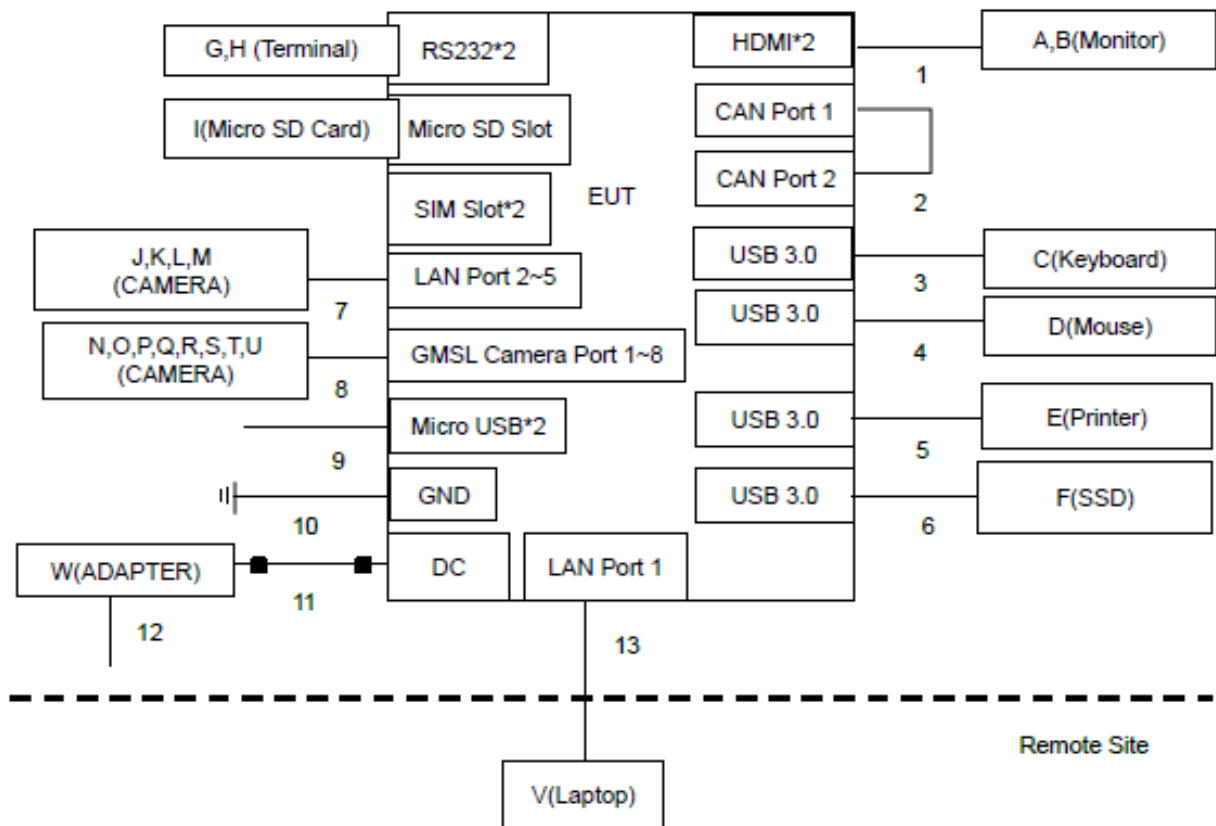

Harmonics & Flicker & Immunity tests:

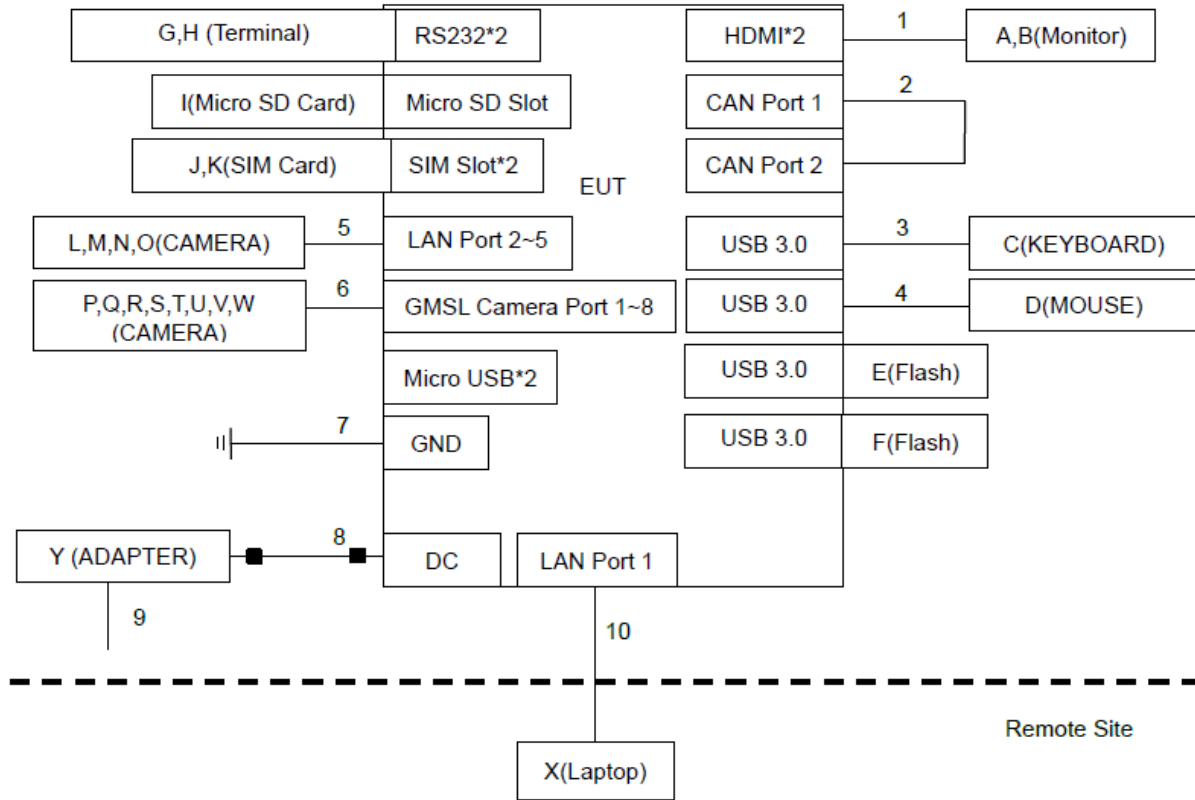

4.2 Configuration of Peripheral Devices and Cable Connections

Emission tests (Harmonics & Flicker excluded):

ID	Product	Brand	Model No.	Serial No.	FCC ID	Remarks
A	Monitor	ASUS	PA279CV	M7LMTF235958	DoC	Provided by Lab
B	Monitor	ASUS	PA279CV	M7LMTF236012	DoC	Provided by Lab
C	USB Keyboard	Dell	KB216t	CN-0W33XP-LO300-7CL-191E	N/A	Provided by Lab
D	USB Mouse	DELL	MOCZUL	CN-049TWY-PRC00-77B-007R	N/A	Provided by Lab
E	Printer	HP	HP Officejet Pro 251dW	N/A	B94SDGOB1191	Provided by Lab
F	USB 3.1 SSD	Crucial	CT500X8SSD9	1941E323D093	N/A	Provided by Lab
G	Terminal	N/A	N/A	N/A	N/A	Supplied by applicant
H	Terminal	N/A	N/A	N/A	N/A	Supplied by applicant
I	Micro SD Card	SanDisk	16GB	N/A	N/A	Supplied by applicant
J	CAMERA	3MP	A301RZ-0309P	T42211285	N/A	Supplied by applicant
K	CAMERA	3MP	A301RZ-0309P	T42211278	N/A	Supplied by applicant
L	CAMERA	3MP	A301RZ-0309P	T42211283	N/A	Supplied by applicant
M	CAMERA	3MP	A301RZ-0309P	T42211277	N/A	Supplied by applicant
N	CAMERA	oToBrite	oToCAM264ISP-N186M	N/A	N/A	Supplied by applicant
O	CAMERA	oToBrite	oToCAM264ISP-N186M	N/A	N/A	Supplied by applicant
P	CAMERA	oToBrite	oToCAM264ISP-N186M	N/A	N/A	Supplied by applicant
Q	CAMERA	oToBrite	oToCAM264ISP-N186M	N/A	N/A	Supplied by applicant
R	CAMERA	oToBrite	oToCAM264ISP-N186M	N/A	N/A	Supplied by applicant
S	CAMERA	oToBrite	oToCAM264ISP-N186M	N/A	N/A	Supplied by applicant
T	CAMERA	oToBrite	oToCAM264ISP-N186M	N/A	N/A	Supplied by applicant
U	CAMERA	oToBrite	oToCAM264ISP-N186M	N/A	N/A	Supplied by applicant
V	Laptop	LENOVO	T480	PF1EK03U	N/A	Provided by Lab
W	Adapter	LITEON	PA-1181-28	N/A	N/A	Supplied by applicant

ID	Cable Descriptions	Qty.	Length (m)	Shielding (Yes/No)	Cores (Qty.)	Remarks
1	HDMI cable	2	2	Yes	0	Provided by Lab, HDMI 2.0 (Brand: Amber, Model: HDMI-AA120)
2	Data cable	3	0.1	No	0	Supplied by applicant
3	USB cable	1	1.8	Yes	0	Provided by Lab
4	USB cable	1	1.8	Yes	0	Provided by Lab
5	USB cable	1	1.8	Yes	0	Provided by Lab
6	USB Type A to C cable	3	1	Yes	0	Provided by Lab
7	RJ45 (Cat. 5e) cable	4	1.5	Yes	0	Provided by Lab
8	GMSL cable	8	3.5	Yes	0	Supplied by applicant
9	USB (Micro) cable	2	1	Yes	0	Provided by Lab
10	GND (PE) cable	1	1.5	No	0	Provided by Lab
11	DC power cable	1	1.6	No	2	Supplied by applicant
12	AC power(3pin) cable	1	1.8	No	0	Provided by Lab
13	RJ45 (Cat. 5e) cable	1	10	Yes	0	Provided by Lab

Harmonics, Flicker, Immunity tests:

ID	Product	Brand	Model No.	Serial No.	FCC ID	Remarks
A	Monitor	ASUS	MG28UQ	H8LMTF147971	N/A	Provided by Lab
B	Monitor	Vita	VT-270JTG2	204270JTFE001	DoC	Provided by Lab
C	KEYBOARD	DELL	SK-8115	CN-0J4635-71616-63I-076F	DoC	Provided by Lab
D	MOUSE	DELL	M056UOA	FOROOSWW	DoC	Provided by Lab
E	Flash	HP	x750w	32G	N/A	Provided by Lab
F	Flash	HP	x750w	32G	N/A	Provided by Lab
G	Terminal	N/A	N/A	N/A	N/A	Supplied by applicant
H	Terminal	N/A	N/A	N/A	N/A	Supplied by applicant
I	Micro SD Card	SanDisk	16GB	N/A	N/A	Supplied by applicant
J	SIM Card	R&S	N/A	N/A	N/A	Provided by Lab
K	SIM Card	R&S	N/A	N/A	N/A	Provided by Lab
L	CAMERA	3MP	A301RZ-0309P	T42211285	N/A	Supplied by applicant
M	CAMERA	3MP	A301RZ-0309P	T42211278	N/A	Supplied by applicant
N	CAMERA	3MP	A301RZ-0309P	T42211283	N/A	Supplied by applicant
O	CAMERA	3MP	A301RZ-0309P	T42211277	N/A	Supplied by applicant
P	CAMERA	oToBrite	oToCAM264ISP-N 186M	N/A	N/A	Supplied by applicant
Q	CAMERA	oToBrite	oToCAM264ISP-N 186M	N/A	N/A	Supplied by applicant
R	CAMERA	oToBrite	oToCAM264ISP-N 186M	N/A	N/A	Supplied by applicant
S	CAMERA	oToBrite	oToCAM264ISP-N 186M	N/A	N/A	Supplied by applicant
T	CAMERA	oToBrite	oToCAM264ISP-N 186M	N/A	N/A	Supplied by applicant
U	CAMERA	oToBrite	oToCAM264ISP-N 186M	N/A	N/A	Supplied by applicant
V	CAMERA	oToBrite	oToCAM264ISP-N 186M	N/A	N/A	Supplied by applicant
W	CAMERA	oToBrite	oToCAM264ISP-N 186M	N/A	N/A	Supplied by applicant
X	Laptop	LENOVO	T480	PF1EK03U	N/A	Provided by Lab
Y	Adapter	LITEON	PA-1181-28	N/A	N/A	Supplied by applicant

ID	Cable Descriptions	Qty.	Length (m)	Shielding (Yes/No)	Cores (Qty.)	Remarks
1	HDMI cable	2	2	Yes	0	Provided by Lab, HDMI 2.0 (Brand: Amber, Model: HDMI-AA120)
2	Data cable	3	0.1	No	0	Supplied by applicant
3	USB 2.0 cable	1	1.8	Yes	0	Provided by Lab
4	USB 2.0 cable	1	1.8	Yes	0	Provided by Lab
5	RJ45 (Cat. 5e) cable	4	5	Yes	0	Provided by Lab
6	GMSL cable	8	3.5	Yes	0	Supplied by applicant
7	GND (PE) cable	1	1.8	No	0	Provided by Lab
8	DC power cable	1	1.6	No	2	Supplied by applicant
9	AC power(3pin) cable	1	1.8	No	0	Provided by Lab
10	RJ45 (Cat. 5e) cable	1	10	Yes	0	Provided by Lab

5 Conducted Disturbance at Auxiliary a.c. or d.c. Power Ports

5.1 Limits

Frequency (MHz)	Quasi-peak, (dBuV)
0.15 - 0.5	99
0.5 - 30	93

Notes: 1. The lower limit shall apply at the transition frequencies.
 2. The limit decreases linearly with the logarithm of the frequency in the range of 0.15 to 0.50 MHz.

5.2 Test Instruments

Description Manufacturer	Model No.	Serial No.	Calibrated Date	Calibrated Until
50 ohm terminal LYNICS	0900510	E1-011285	2022/9/19	2023/9/18
		E1-011286	2022/9/19	2023/9/18
50 Ohms Terminator LYNICS	0900510	E1-01-305	2023/2/13	2024/2/12
Attenuator STI	STI02-2200-10	NO.3	2022/10/21	2023/10/20
Coupling/Dcoupling Network Schwarzbeck	CDNE-M2	00097	2022/6/1	2023/5/31
		CDNE-M3	00091	2022/6/1
Coupling/Dcoupling Network TESEQ	CDN A201A	44601	2022/12/14	2023/12/13
DC LISN R&S	ESH3-Z6	100219	2022/8/2	2023/8/1
		844950/018	2022/8/2	2023/8/1
DC LISN Schwarzbeck	NNLK 8121	8121-808	2022/4/29	2023/4/28
High Voltage Probe Schwarzbeck	TK9420	00982	2022/12/14	2023/12/13
Isolation Transformer Erika Fiedler	D-65396	017	2022/9/8	2023/9/7
LISN EMCO	3825/2	9204-1964	2022/6/17	2023/6/16
		9504-2359	2022/8/2	2023/8/1
LISN R&S	ENV216	101195	2022/8/1	2023/7/31
		101196	2022/5/24	2023/5/23
		101197	2022/7/5	2023/7/4
LISN Schwarzbeck	NNLK 8121	8121-731	2022/5/26	2023/5/25
		8121-00759	2022/8/18	2023/8/17
	NNLK8129	8129229	2022/6/8	2023/6/7
RF Coaxial Cable Commate	5D-FB	Cable-CO3-01	2022/9/14	2023/9/13
Software BVADT	Cond_V7.3.7.4	N/A	N/A	N/A
Test Receiver R&S	ESR3	102413	2023/2/7	2024/2/6

Notes:

1. The calibration interval of the above test instruments is 12 months and the calibrations are traceable to NML/ROC and NIST/USA.
2. The test was performed in Linkou Conduction 3.
3. T The VCCI Site Registration No. C-10274.
4. Tested Date: 2023/3/15

5.3 Test Arrangement

- The EUT was placed 0.4 meters from the conducting wall of the shielded room with EUT being connected to the power mains through a line impedance stabilization network (LISN). Other support units were connected to the power mains through another LISN. The two LISNs provide 50 Ohm/ 50uH of coupling impedance for the measuring instrument.
- Both lines of the power mains connected to the EUT were checked for maximum conducted interference.
- The test results of conducted emissions at mains ports are recorded of six worst margins for quasi-peak (mandatory) [and average (if necessary)] values against the limits at frequencies of interest unless the margin is 20 dB or greater.

Note: The resolution bandwidth and video bandwidth of test receiver is 9kHz for quasi-peak detection (QP) and average detection (AV) at frequency 0.15MHz-30MHz.

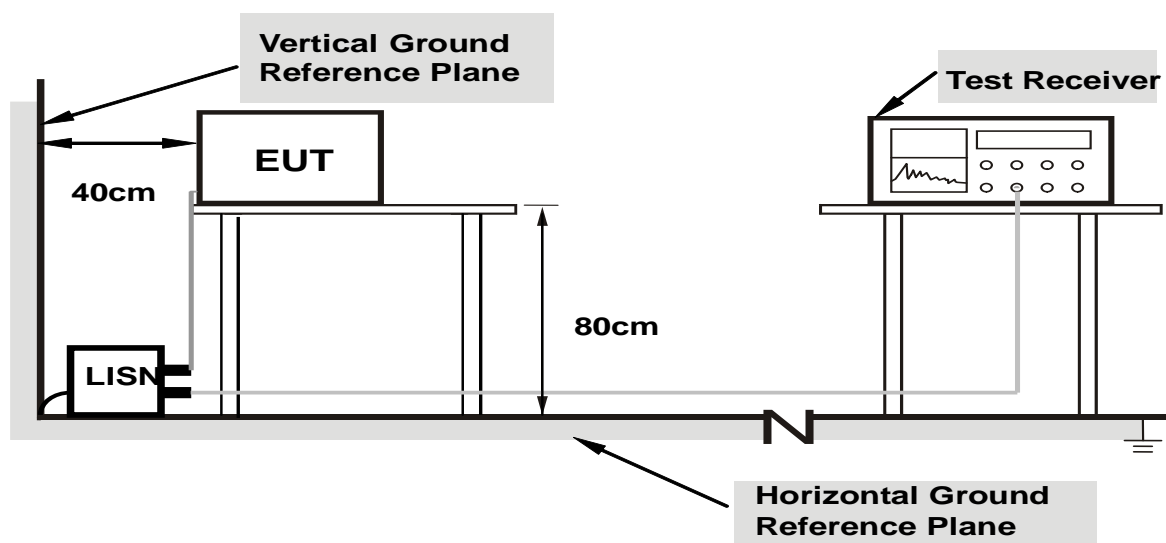

Note: Support units were connected to second LISN.

For the actual test configuration, please refer to the related item – Photographs of the Test Configuration.

5.4 Test Results

Mode A

Frequency Range	150 kHz ~ 30 MHz	Detector Function & Resolution Bandwidth	Quasi-Peak (QP), 9kHz
Input Power	230 Vac, 50 Hz	Environmental Conditions	22°C, 70% RH
Tested by	Perry Yang		

Phase Of Power : Line (L)						
No	Frequency (MHz)	Correction Factor (dB)	Reading Value (dBuV)	Emission Level (dBuV)	Limit (dBuV)	Margin (dB)
			Q.P.	Q.P.	Q.P.	Q.P.
1	0.15391	9.65	37.06	46.71	99.00	-52.29
2	0.18539	9.65	39.42	49.07	99.00	-49.93
3	0.23213	9.65	40.49	50.14	99.00	-48.86
4	0.48635	9.65	31.97	41.62	99.00	-57.38
5	0.71368	9.66	32.97	42.63	93.00	-50.37
6	1.57553	9.68	33.66	43.34	93.00	-49.66

Remarks:

1. Q.P. is abbreviations of quasi-peak individually.
2. The emission levels of other frequencies were very low against the limit.
3. Margin value = Emission level – Limit value
4. Correction factor = Insertion loss + Cable loss
5. Emission Level = Correction Factor + Reading Value

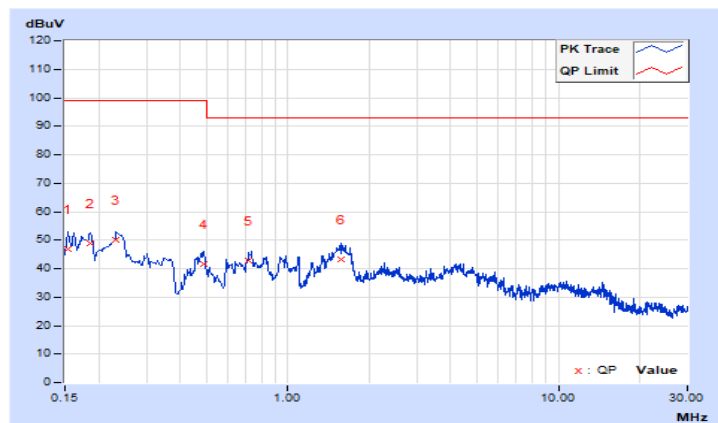

Frequency Range	150 kHz ~ 30 MHz	Detector Function & Resolution Bandwidth	Quasi-Peak (QP), 9kHz
Input Power	230 Vac, 50 Hz	Environmental Conditions	20°C, 86% RH
Tested by	Perry Yang		

Phase Of Power : Neutral (N)						
No	Frequency (MHz)	Correction Factor (dB)	Reading Value (dBuV)	Emission Level (dBuV)	Limit (dBuV)	Margin (dB)
			Q.P.	Q.P.	Q.P.	Q.P.
1	0.15012	9.65	40.84	50.49	99.00	-48.51
2	0.16096	9.65	39.87	49.52	99.00	-49.48
3	0.46564	9.65	34.40	44.05	99.00	-54.95
4	0.71119	9.66	32.40	42.06	93.00	-50.94
5	1.58726	9.69	33.05	42.74	93.00	-50.26
6	4.30149	9.77	28.61	38.38	93.00	-54.62

Remarks:

1. Q.P. is abbreviations of quasi-peak individually.
2. The emission levels of other frequencies were very low against the limit.
3. Margin value = Emission level – Limit value
4. Correction factor = Insertion loss + Cable loss
5. Emission Level = Correction Factor + Reading Value

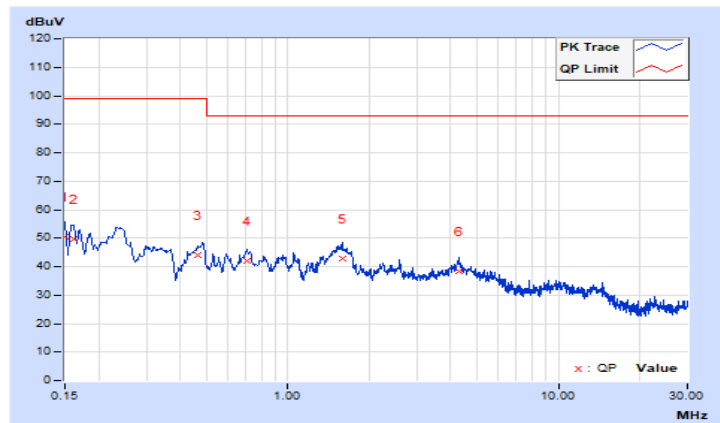

6 Radiated Disturbance up to 1 GHz

6.1 Limits

Frequency (MHz)	dBuV/m (at 10m) / quasi-peak
30 - 230	40
230 - 1000	47

- Notes:
1. The lower limit shall apply at the transition frequencies.
 2. Emission level (dBuV/m) = 20 log Emission level (uV/m).
 3. All emanations from a class A/B digital device or system, including any network of conductors and apparatus connected thereto, shall not exceed the level of field strengths specified above.

6.2 Test Instruments

Description Manufacturer	Model No.	Serial No.	Calibrated Date	Calibrated Until
ADT. Tower	AT100	0205	N/A	N/A
ADT. Turn Table	TT100	0205	N/A	N/A
Attenuator Mini-Circuits	UNAT-5+	PAD-ST2-01	2022/10/21	2023/10/20
Bi-log Broadband Antenna Schwarzbeck	VULB9168	9168-303	2022/10/25	2023/10/24
Coupling/Dcoupling Network Schwarzbeck	CDNE-M2	00097	2022/6/1	2023/5/31
	CDNE-M3	00091	2022/6/1	2023/5/31
Preamplifier Agilent	8447D	2944A11062	2023/2/15	2024/2/14
Pre_Amplifier EMCI	EMC9135	980711	2023/3/12	2024/3/11
Pre_Amplifier HP	8447D	2944A08313	2023/2/15	2024/2/14
RF Coaxial Cable Pacific	8D-FB	Cable-ST2-01	2022/10/21	2023/10/20
Software BVADT	Radiated_V7.6.15.9.5	N/A	N/A	N/A
TEST RECEIVER R&S	ESCS 30	100276	2022/4/19	2023/4/18
		100292	2022/8/30	2023/8/29

Notes:

1. The calibration interval of the above test instruments is 12 months and the calibrations are traceable to NML/ROC and NIST/USA.
2. The test was performed in Linkou Open Site2 , The test site validated date: 2022/7/16 (NSA)
3. The VCCI Site Registration No. R-10237.
4. Tested Date: 2023/3/14

6.3 Test Arrangement

- The EUT was placed on the top of a rotating table 0.8 meters above the ground at an accredited test facility. The table was rotated 360 degrees to determine the position of the highest radiation.
- The EUT was set 10 meters away from the interference-receiving antenna, which was mounted on the top of a variable-height antenna tower.
- The antenna is a broadband antenna, and its height is varied from one meter to four meters above the ground to determine the maximum value of the field strength. Both horizontal and vertical polarizations of the antenna are set to make the measurement.
- For each suspected emission, the EUT was arranged to its worst case and then the antenna was tuned to heights from 1 meter to 4 meters and the rotatable table was turned from 0 degrees to 360 degrees to find the maximum reading.
- The test-receiver system was set to quasi-peak detect function and specified bandwidth with maximum hold mode when the test frequency is up to 1 GHz.

Note: The resolution bandwidth and video bandwidth of test receiver/spectrum analyzer is 120kHz for quasi-peak detection (QP) at frequency up to 1GHz.

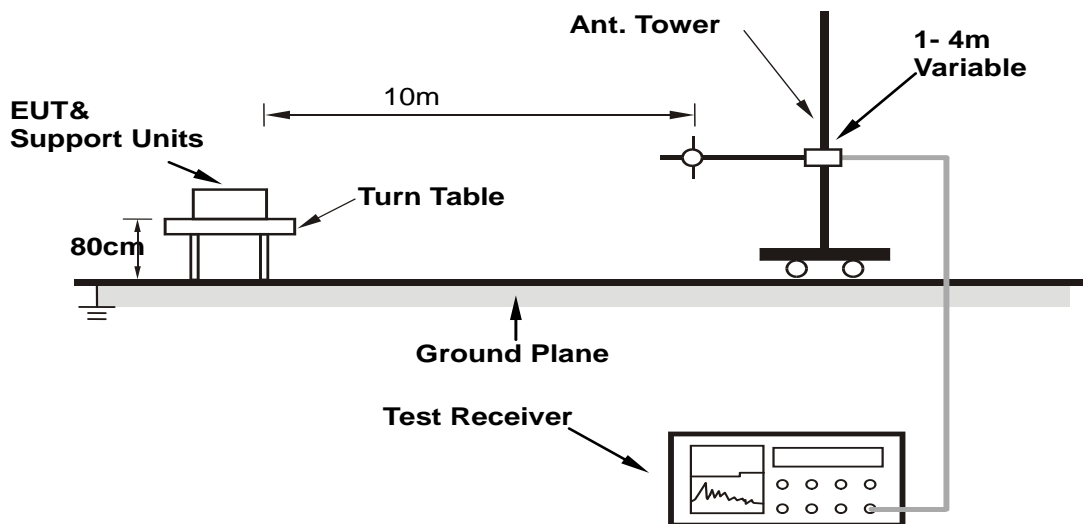

For the actual test configuration, please refer to the related item – Photographs of the Test Configuration.

6.4 Test Results

Mode A

Frequency Range	30 MHz ~ 1 GHz	Detector Function & Resolution Bandwidth	Quasi-Peak (QP), 120 kHz
Input Power	230 Vac, 50 Hz	Environmental Conditions	21°C, 63% RH
Tested By	Paul Chen		

Antenna Polarity & Test Distance : Horizontal at 10 m

No	Frequency (MHz)	Emission Level (dBuV/m)	Limit (dBuV/m)	Margin (dB)	Antenna Height (m)	Table Angle (Degree)	Raw Value (dBuV)	Correction Factor (dB/m)
1	74.26	30.11 QP	40.00	-9.89	4.00 H	119	41.87	-11.76
2	125.01	34.73 QP	40.00	-5.27	4.00 H	294	44.55	-9.82
3	148.51	27.29 QP	40.00	-12.71	4.00 H	333	35.28	-7.99
4	200.02	32.54 QP	40.00	-7.46	4.00 H	128	43.29	-10.75
5	249.99	37.62 QP	47.00	-9.38	3.91 H	228	45.72	-8.10
6	350.03	37.78 QP	47.00	-9.22	3.13 H	256	42.79	-5.01
7	425.51	37.97 QP	47.00	-9.03	2.25 H	49	41.02	-3.05
8	445.51	35.26 QP	47.00	-11.74	1.98 H	247	37.74	-2.48
9	525.00	36.02 QP	47.00	-10.98	1.66 H	97	37.25	-1.23
10	625.01	32.78 QP	47.00	-14.22	1.24 H	336	30.97	1.81
11	891.00	35.83 QP	47.00	-11.17	1.00 H	120	28.35	7.48
12	975.86	40.12 QP	47.00	-6.88	1.00 H	136	30.95	9.17

Remarks:

1. Emission Level(dBuV/m) = Raw Value(dBuV) + Correction Factor(dB/m)
2. Correction Factor(dB/m) = Antenna Factor (dB/m) + Cable Factor (dB)
– Pre-Amplifier Factor (dB)
3. The other emission levels were very low against the limit.
4. Margin value = Emission level – Limit value

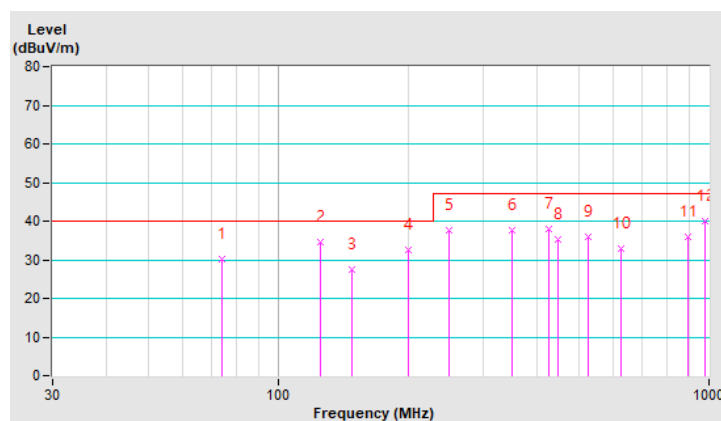

Frequency Range	30 MHz ~ 1 GHz	Detector Function & Resolution Bandwidth	Quasi-Peak (QP), 120 kHz
Input Power	230 Vac, 50 Hz	Environmental Conditions	21°C, 63% RH
Tested By	Paul Chen		

Antenna Polarity & Test Distance : Vertical at 10 m								
No	Frequency (MHz)	Emission Level (dBuV/m)	Limit (dBuV/m)	Margin (dB)	Antenna Height (m)	Table Angle (Degree)	Raw Value (dBuV)	Correction Factor (dB/m)
1	37.26	27.11 QP	40.00	-12.89	1.28 V	144	36.50	-9.39
2	76.24	30.53 QP	40.00	-9.47	1.78 V	224	42.85	-12.32
3	125.01	34.16 QP	40.00	-5.84	1.00 V	111	43.98	-9.82
4	148.51	30.02 QP	40.00	-9.98	1.00 V	183	38.01	-7.99
5	195.24	31.96 QP	40.00	-8.04	1.00 V	234	42.68	-10.72
6	216.07	31.02 QP	40.00	-8.98	1.00 V	194	41.41	-10.39
7	249.99	32.67 QP	47.00	-14.33	1.00 V	288	40.77	-8.10
8	300.02	31.45 QP	47.00	-15.55	1.00 V	199	37.48	-6.03
9	375.02	32.87 QP	47.00	-14.13	1.00 V	336	37.15	-4.28
10	424.99	37.15 QP	47.00	-9.85	1.00 V	190	40.23	-3.08
11	445.51	32.51 QP	47.00	-14.49	1.00 V	263	34.99	-2.48
12	625.01	30.15 QP	47.00	-16.85	3.19 V	278	28.34	1.81
13	891.01	34.53 QP	47.00	-12.47	2.13 V	316	27.05	7.48

Remarks:

1. Emission Level(dBuV/m) = Raw Value(dBuV) + Correction Factor(dB/m)
2. Correction Factor(dB/m) = Antenna Factor (dB/m) + Cable Factor (dB) – Pre-Amplifier Factor (dB)
3. The other emission levels were very low against the limit.
4. Margin value = Emission level – Limit value

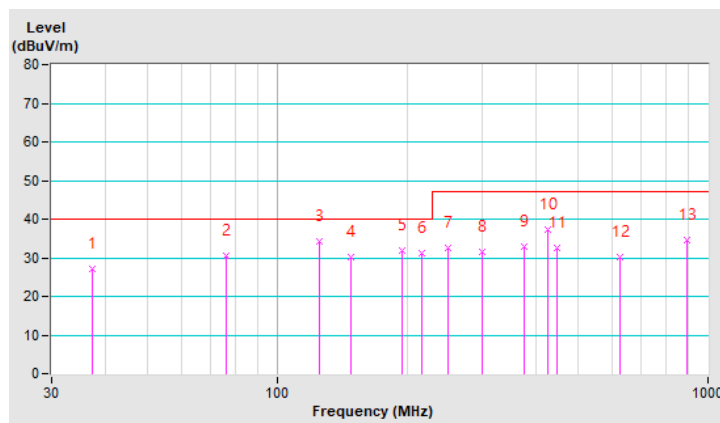

7 Radiated Disturbance above 1 GHz

7.1 Limits

Frequency (GHz)	dBuV/m (at 3m)	
	Average	Peak
1 to 3	56	76
3 to 6	60	80

- Notes: 1. The lower limit shall apply at the transition frequencies.
 2. Emission level (dBuV/m) = 20 log Emission level (uV/m).
 3. All emanations from a class A/B digital device or system, including any network of conductors and apparatus connected thereto, shall not exceed the level of field strengths specified above.

Frequency Range (For unintentional radiators)

Highest frequency generated or used in the EUT or on which the EUT operates or tunes (MHz)	Upper frequency of measurement range (MHz)
Below 108	1000
108-500	2000
500-1000	5000
Above 1000	Up to 5 times of the highest frequency or 6 GHz, whichever is less

7.2 Test Instruments

Description Manufacturer	Model No.	Serial No.	Calibrated Date	Calibrated Until
Attenuator Mini-Circuits	BW-K3-2W44+	PAD-CH7-03	2022/7/7	2023/7/6
	BW-N4W5+	PAD-CH10-02	2022/7/7	2023/7/6
Band Pass Filter MICRO-TRONICS	BRM17690	005	2022/5/26	2023/5/25
Fix tool for Boresight antenna tower BV	BAF-01	9	N/A	N/A
Horn Antenna EMCO	3115	6714	2022/11/13	2023/11/12
Horn Antenna ETS-Lindgren	3117-PA	00215857	2023/2/3	2024/2/2
Horn Antenna Schwarzbeck	BBHA 9170	212	2022/10/20	2023/10/19
Notch Filter MICRO-TRONICS	BRC50703-01	010	2022/5/26	2023/5/25
Pre-amplifier HP	8449B	3008A01292	2023/2/16	2024/2/15
Pre_Amplifier EMCI	EMC0126545	980076	2023/2/16	2024/2/15
	EMC184045B	980235	2023/2/16	2024/2/15
RF Coaxial Cable EM	EM102-KMKM-3.5	EM102-KMKM-3.5-02	2022/9/27	2023/9/26
RF Coaxial Cable WOKEN	WC01	Cable-CH10-03	2022/9/27	2023/9/26
Software BVADT	Radiated_V8.7.08	N/A	N/A	N/A
Spectrum Keysight	N9020B	MY60110438	2022/12/6	2023/12/5
		MY60112260	2022/5/21	2023/5/20
Test Receiver Agilent	N9038A	MY51210137	2022/6/9	2023/6/8
Turn Table & Tower Max Full	MF7802	MF780208216	N/A	N/A

Notes:

1. The calibration interval of the above test instruments is 12 months and the calibrations are traceable to NML/ROC and NIST/USA.
2. The test was performed in Linkou 966 Chamber 3 (CH 10).
3. The VCCI Site Registration No. G-10427.
4. Tested Date: 2023/3/15

7.3 Test Arrangement

- The EUT was placed on the top of a rotating table 0.8 meters above the ground at an accredited chamber room. The table was rotated 360 degrees to determine the position of the highest radiation.
- The EUT was set 3 meters away from the interference-receiving antenna, which was mounted on the top of a variable-height antenna tower.
- The height of antenna can be varied from one meter to four meters, the height of adjustment depends on the EUT height and the antenna 3dB beamwidth both, to detect the maximum value of the field strength. Both horizontal and vertical polarizations of the antenna are set to make the measurement.
- For each suspected emission, the EUT was arranged to its worst case and then the antenna was tuned to heights and the rotatable table was turned from 0 degrees to 360 degrees to find the maximum reading.
- The spectrum analyzer system was set to peak and average detect function and specified bandwidth with maximum hold mode when the test frequency is above 1 GHz.

Note: The resolution bandwidth of test receiver/spectrum analyzer is 1MHz and video bandwidth is 3MHz for Peak detection (PK) at frequency above 1GHz. The resolution bandwidth of test receiver/spectrum analyzer is 1 MHz for Average detection (AV) at frequency above 1GHz.

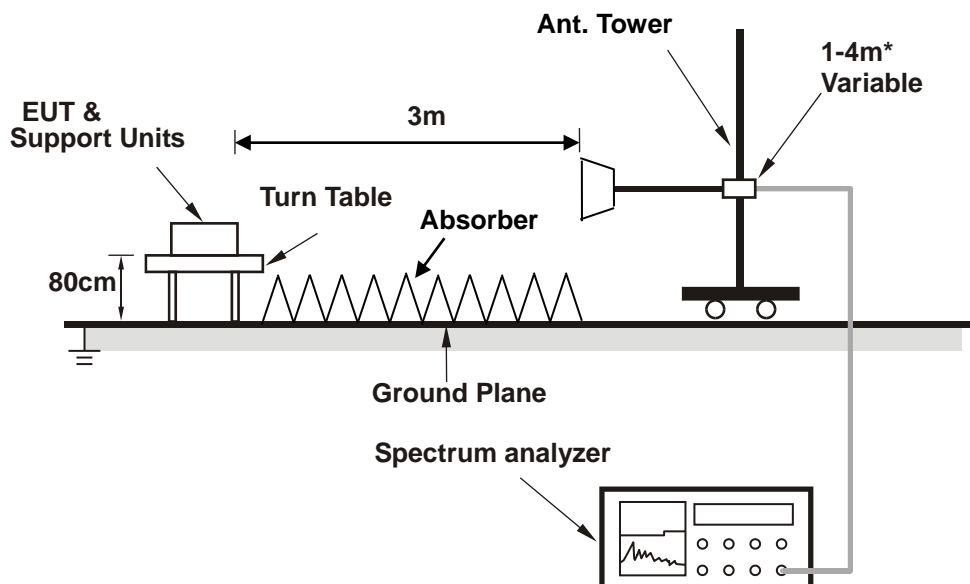

* :depends on the EUT height and the antenna 3dB beamwidth both.

For the actual test configuration, please refer to the related item – Photographs of the Test Configuration.

7.4 Test Results

Mode A

Frequency Range	1 GHz ~ 6 GHz	Detector Function & Resolution Bandwidth	Peak (PK) / Average (AV), 1MHz
Input Power	230 Vac, 50 Hz	Environmental Conditions	22°C, 70% RH
Tested By	Perry Yang		

Antenna Polarity & Test Distance : Horizontal at 3 m

No	Frequency (MHz)	Emission Level (dBuV/m)	Limit (dBuV/m)	Margin (dB)	Antenna Height (m)	Table Angle (Degree)	Raw Value (dBuV)	Correction Factor (dB/m)
1	1970.92	49.58 PK	76.00	-26.42	1.02 H	168	51.21	-1.63
2	1970.92	42.02 AV	56.00	-13.98	1.02 H	168	43.65	-1.63
3	2187.07	52.46 PK	76.00	-23.54	1.92 H	199	53.60	-1.14
4	2187.07	45.31 AV	56.00	-10.69	1.92 H	199	46.45	-1.14
5	2395.12	48.63 PK	76.00	-27.37	3.04 H	175	48.70	-0.07
6	2395.12	35.21 AV	56.00	-20.79	3.04 H	175	35.28	-0.07
7	2863.88	52.16 PK	76.00	-23.84	1.00 H	195	50.85	1.31
8	2863.88	38.58 AV	56.00	-17.42	1.00 H	195	37.27	1.31
9	3377.20	50.97 PK	80.00	-29.03	1.87 H	113	47.60	3.37
10	3377.20	37.73 AV	60.00	-22.27	1.87 H	113	34.36	3.37
11	5388.14	51.02 PK	80.00	-28.98	2.40 H	90	41.96	9.06
12	5388.14	37.53 AV	60.00	-22.47	2.40 H	90	28.47	9.06

Remarks:

1. Emission Level(dBuV/m) = Raw Value(dBuV) + Correction Factor(dB/m)
2. Correction Factor(dB/m) = Antenna Factor (dB/m) + Cable Factor (dB)
– Pre-Amplifier Factor (dB)
3. The other emission levels were very low against the limit.
4. Margin value = Emission level – Limit value

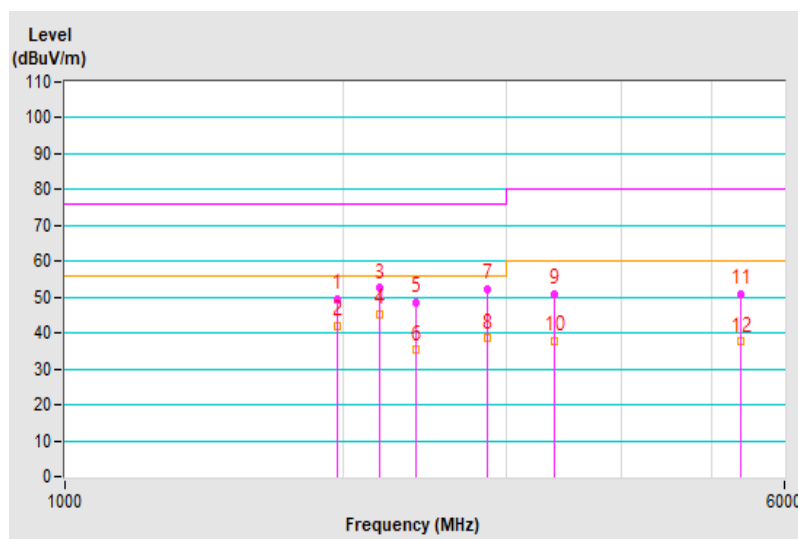

Frequency Range	1 GHz ~ 6 GHz	Detector Function & Resolution Bandwidth	Peak (PK) / Average (AV), 1MHz
Input Power	230 Vac, 50 Hz	Environmental Conditions	22°C, 70% RH
Tested By	Perry Yang		

Antenna Polarity & Test Distance : Vertical at 3 m								
No	Frequency (MHz)	Emission Level (dBuV/m)	Limit (dBuV/m)	Margin (dB)	Antenna Height (m)	Table Angle (Degree)	Raw Value (dBuV)	Correction Factor (dB/m)
1	1368.05	48.07 PK	76.00	-27.93	1.88 V	339	51.98	-3.91
2	1368.05	36.31 AV	56.00	-19.69	1.88 V	339	40.22	-3.91
3	1808.69	51.56 PK	76.00	-24.44	2.06 V	186	53.74	-2.18
4	1808.69	40.50 AV	56.00	-15.50	2.06 V	186	42.68	-2.18
5	2133.01	52.90 PK	76.00	-23.10	2.15 V	183	54.03	-1.13
6	2133.01	46.47 AV	56.00	-9.53	2.15 V	183	47.60	-1.13
7	2186.90	54.08 PK	76.00	-21.92	2.08 V	190	55.22	-1.14
8	2186.90	48.03 AV	56.00	-7.97	2.08 V	190	49.17	-1.14
9	2699.15	49.88 PK	76.00	-26.12	2.00 V	193	49.03	0.85
10	2699.15	38.44 AV	56.00	-17.56	2.00 V	193	37.59	0.85
11	5399.97	54.56 PK	80.00	-25.44	1.00 V	185	45.50	9.06
12	5399.97	43.06 AV	60.00	-16.94	1.00 V	185	34.00	9.06

Remarks:

1. Emission Level(dBuV/m) = Raw Value(dBuV) + Correction Factor(dB/m)
2. Correction Factor(dB/m) = Antenna Factor (dB/m) + Cable Factor (dB) – Pre-Amplifier Factor (dB)
3. The other emission levels were very low against the limit.
4. Margin value = Emission level – Limit value

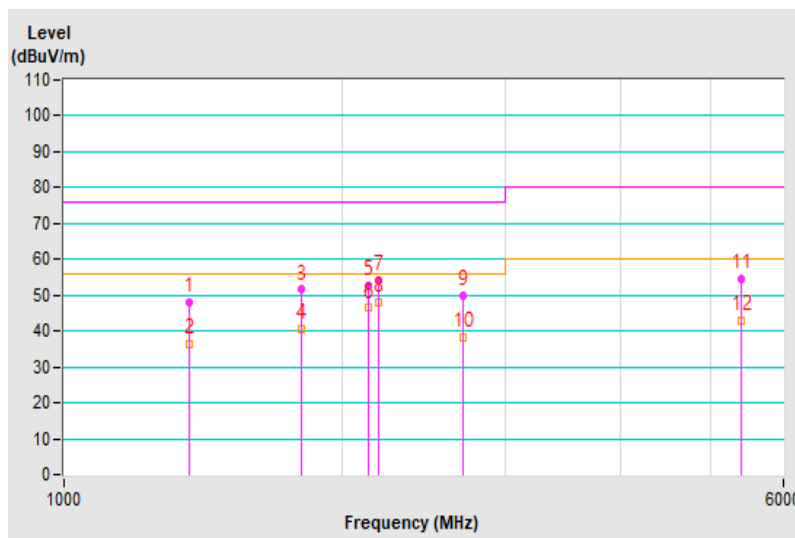

8 Harmonics Current Measurement

8.1 Limits

Limits for Class A equipment		Limits for Class D equipment		
Harmonic Order n	Max. permissible harmonics current A	Harmonic Order n	Max. permissible harmonics current per watt mA/W	Max. permissible harmonics current A
Odd harmonics		Odd Harmonics only		
3	2.30	3	3.4	2.30
5	1.14	5	1.9	1.14
7	0.77	7	1.0	0.77
9	0.40	9	0.5	0.40
11	0.33	11	0.35	0.33
13	0.21	13	0.30	0.21
15 ≤ n ≤ 39	0.15 x 15/n	15 ≤ n ≤ 39	3.85/n	0.15 x 15/n
Even harmonics				
2	1.08			
4	0.43			
6	0.30			
8 ≤ n ≤ 40	0.23 x 8/n			

- Notes: 1. Class A and Class D are classified according to section 5 of EN 61000-3-2.
 2. According to section 7 of EN 61000-3-2, the above limits for all equipment except for lighting equipment having an active input power > 75 W and no limits apply for equipment with an active input power up to and including 75 W.

8.2 Classification of Equipment

Class A	Class B	Class C	Class D
Balanced three-phase equipment; Household appliances excluding equipment as Class D; Tools excluding portable tools; Dimmers for incandescent lamps; Audio equipment; Equipment not specified in one of the three other classes.	Portable tools; Arc welding equipment which is not professional equipment.	Lighting equipment.	Equipment having a specified power less than or equal to 600 W of the following types: Personal computers and personal computer monitors; Television receivers; Refrigerators and freezers having one or more variable-speed drives to control compressor motor(s).

8.3 Test Instruments

Description Manufacturer	Model No.	Serial No.	Calibrated Date	Calibrated Until
Harmonics and Flicker TESEQ	NSG1007 / NSG2196 / NSG2197	1323A03998	2022/4/26	2023/4/25
Software	CTS MXH	N/A	N/A	N/A

Notes:

- The calibration interval of the above test instruments is 12 months and the calibrations are traceable to NML/ROC and NIST/USA.
- The test was performed in Linkou EMS Room No.02.
- Tested Date: 2023/3/20

8.4 Test Arrangement

- a. The EUT was placed on the top of a wooden table 0.8 meters above the ground and operated to produce the maximum harmonic components under normal operating conditions for each successive harmonic component in turn.
- b. The correspondent test program of test instrument to measure the current harmonics emanated from EUT is chosen. The measure time shall be not less than the time necessary for the EUT to be exercised.

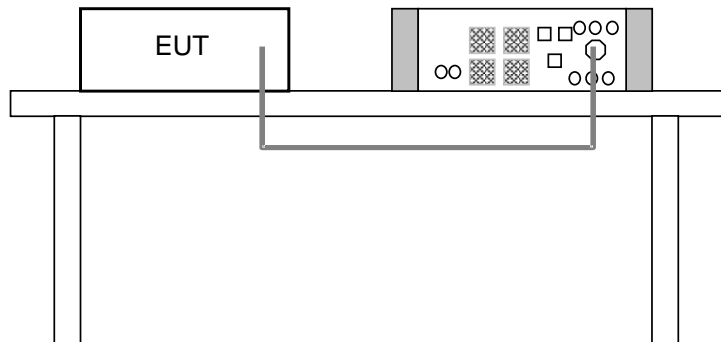

For the actual test configuration, please refer to the related item – Photographs of the Test Configuration.

8.5 Test Results

Mode A

Test Duration	5 min	Fundamental Voltage / Ampere	230.534 Vrms / 0.396 Arms
Power Consumption	79.5 W	Power Frequency	50 Hz
Power Factor	0.893	Environmental Conditions	22°C, 74% RH
Tested By	Eric Liao		

Harm#	Harms (avg) (A)	100% Limit (A)	Harms (max) (A)	150% Limit (A)
1	0.361	-	1.584	-
2	0.002	1.080	0.002	1.620
3	0.116	2.300	0.125	3.450
4	0.002	0.430	0.003	0.645
5	0.040	1.140	0.043	1.710
6	0.001	0.300	0.002	0.450
7	0.017	0.770	0.019	1.155
8	0.001	0.230	0.001	0.345
9	0.011	0.400	0.012	0.600
10	0.001	0.184	0.002	0.276
11	0.011	0.330	0.013	0.495
12	0.002	0.153	0.003	0.230
13	0.008	0.210	0.009	0.315
14	0.001	0.131	0.002	0.197
15	0.008	0.150	0.009	0.225
16	0.001	0.115	0.002	0.173
17	0.007	0.132	0.010	0.198
18	0.002	0.102	0.003	0.153
19	0.005	0.118	0.007	0.178
20	0.001	0.092	0.002	0.138
21	0.006	0.107	0.007	0.161
22	0.001	0.084	0.001	0.125
23	0.006	0.098	0.006	0.147
24	0.001	0.077	0.001	0.115
25	0.004	0.090	0.006	0.135
26	0.001	0.071	0.001	0.107
27	0.007	0.083	0.009	0.125
28	0.001	0.066	0.001	0.099
29	0.002	0.078	0.003	0.116
30	0.001	0.061	0.001	0.092
31	0.006	0.073	0.007	0.109
32	0.001	0.058	0.001	0.086
33	0.004	0.068	0.005	0.102
34	0.001	0.054	0.001	0.081
35	0.005	0.064	0.006	0.096
36	0.001	0.051	0.001	0.077
37	0.002	0.061	0.002	0.091
38	0.001	0.048	0.001	0.073
39	0.004	0.058	0.004	0.087
40	0.001	0.046	0.001	0.069

Note: Dynamic limits were applied for this test. The highest harmonics values in the above table may not occur at the same window as the maximum harmonics/limit ratio.

9 Voltage Fluctuations and Flicker Measurement

9.1 Limits

Test item	Limit	Note
P_{st}	1.0	P_{st} : short-term flicker severity.
P_{lt}	0.65	P_{lt} : long-term flicker severity.
T_{max} (ms)	500	T_{max} : maximum time duration during the observation period that the voltage deviation $d(t)$ exceeds the limit for d_c .
d_{max} (%)	4	d_{max} : maximum absolute voltage change during an observation period.
d_c (%)	3.3	d_c : maximum steady state voltage change during an observation period.

9.2 Test Instruments

Description Manufacturer	Model No.	Serial No.	Calibrated Date	Calibrated Until
Harmonics and Flicker TESEQ	NSG1007 / NSG2196 / NSG2197	1323A03998	2022/4/26	2023/4/25
Software	CTS MXH	N/A	N/A	N/A

Notes:

- The calibration interval of the above test instruments is 12 months and the calibrations are traceable to NML/ROC and NIST/USA.
- The test was performed in Linkou EMS Room No.02.
- Tested Date: 2023/3/20

9.3 Test Arrangement

- The EUT was placed on the top of a wooden table 0.8 meters above the ground and operated to produce the most unfavorable sequence of voltage changes under normal operating conditions.
- During the flick measurement, the measure time shall include that part of whole operation cycle in which the EUT produce the most unfavorable sequence of voltage changes. The observation period for short-term flicker indicator is 10 minutes and the observation period for long-term flicker indicator is 2 hours.

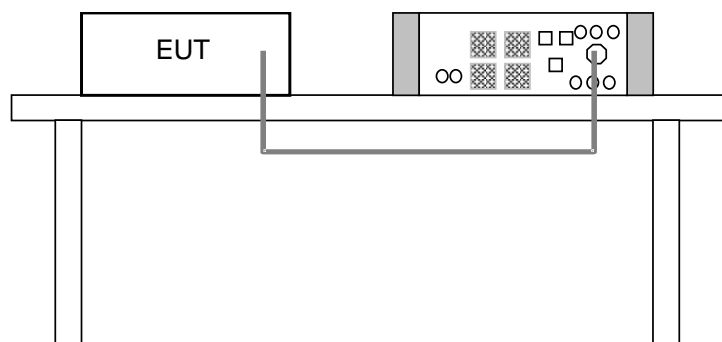

For the actual test configuration, please refer to the related item – Photographs of the Test Configuration.

9.4 Test Results

Mode A

Observation (Tp)	10 min		
Input Power	230 Vac, 50 Hz	Environmental Conditions	22°C, 74% RH
Tested By	Eric Liao		

Test Parameter	Measurement Value	Limit	Remarks
P_{st}	0.166	1.00	Pass
P_{lt}	0.072	0.65	Pass
T_{max} (ms)	0.000	500	Pass
d_{max} (%)	-0.230	4.00	Pass
d_c (%)	0.000	3.30	Pass

Notes:

- a. P_{st} means short-term flicker indicator.
- b. P_{lt} means long-term flicker indicator.
- c. T_{max} means accumulated time value of $d(t)$ with a deviation exceeding 3.3 %.
- d. d_{max} means maximum relative voltage change.
- e. d_c means maximum relative steady-state voltage change.

10 Electrostatic Discharge Immunity Test (ESD)

10.1 Test Specification

Basic Standard:	EN 61000-4-2
Discharge Impedance:	330 ohm / 150 pF
Discharge Voltage:	Air Discharge: $\pm 2, \pm 4, \pm 8$ kV (Direct) Contact Discharge: $\pm 2, \pm 4, \pm 6$ kV (Indirect & Direct)
Number of Discharge:	Minimum 20 times at each test point
Discharge Mode:	Single Discharge
Discharge Period:	1-second minimum

10.2 Test Instruments

Description Manufacturer	Model No.	Serial No.	Calibrated Date	Calibrated Until
Electronic Discharge Simulator Noiseken	ESS-2000	ESS0382041	2022/10/7	2023/10/6
Electrostatic Analog Tester TESEQ	NSG 438	1875	2022/11/11	2023/11/10
ESD Generator EM Test	Dito//DM-150/330//DM- 150/330-rfci	P1315117252/P1317117852	2022/7/7	2023/7/6
ESD Simulator EM TEST	Dito	V0707102251	2022/3/29	2023/3/28
ESD Simulator KeyTek	MZ15/EC	0504259	2022/11/8	2023/11/7
ESD Simulator TESEQ	NSG 438	1364	2022/12/2	2023/12/1

Notes:

1. The calibration interval of the above test instruments is 12 months and the calibrations are traceable to NML/ROC and NIST/USA.
2. The test was performed in Linkou ESD Room No.01.
3. Tested Date: 2023/3/21

10.3 Test Arrangement

- Electrostatic discharges were applied only to those points and surfaces of the EUT that are accessible to users during normal operation.
- The test was performed with at least ten single discharges on the pre-selected points in the most sensitive polarity.
- The time interval between two successive single discharges was at least 1 second.
- The ESD generator was held perpendicularly to the surface to which the discharge was applied and the return cable was at least 0.2 meters from the EUT.
- Contact discharges were applied to the non-insulating coating, with the pointed tip of the generator penetrating the coating and contacting the conducting substrate.
- Air discharges were applied with the round discharge tip of the discharge electrode approaching the EUT as fast as possible (without causing mechanical damage) to touch the EUT. After each discharge, the ESD generator was removed from the EUT and re-triggered for a new single discharge. The test was repeated until all discharges were complete.
- At least ten single discharges (in the most sensitive polarity) were applied to the **Horizontal Coupling Plane** at points on each side of the EUT. The ESD generator was positioned at a distance of 0.1 meters from the EUT with the discharge electrode touching the **HCP**.
- At least ten single discharges (in the most sensitive polarity) were applied to the center of one vertical edge of the **Vertical Coupling Plane** in sufficiently different positions that the four faces of the EUT were completely illuminated. The **VCP** (dimensions 0.5m x 0.5m) was placed vertically to and 0.1 meters from the EUT.

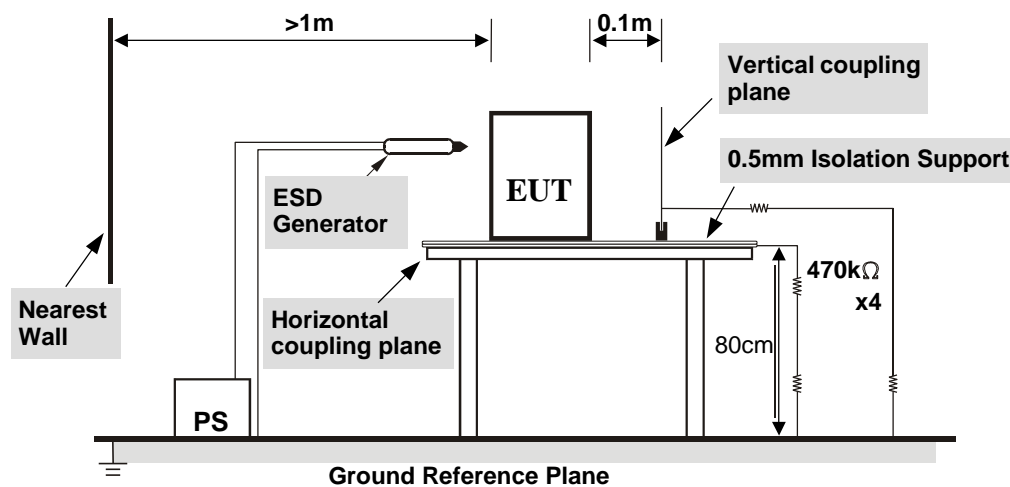

TABLE-TOP EQUIPMENT

The configuration consisted of a wooden table 0.8 meters high standing on the **Ground Reference Plane**. The **GRP** consisted of a sheet of aluminum at least 0.25mm thick, and 2.5 meters square connected to the protective grounding system. A **Horizontal Coupling Plane** (1.6m x 0.8m) was placed on the table and attached to the **GRP** by means of a cable with 940kΩ total impedance. The equipment under test, was installed in a representative system as described in section 7 of EN 61000-4-2, and its cables were placed on the **HCP** and isolated by an insulating support of 0.5mm thickness. A distance of 1-meter minimum was provided between the EUT and the walls of the laboratory and any other metallic structure.

For the actual test configuration, please refer to the related item – Photographs of the Test Configuration.

10.4 Test Results

Mode A

Input Power	230Vac, 50 Hz	Tested by	Sean Chou
Environmental Conditions	22 °C, 45 % RH, 1005 mbar		

Test Results of Direct Application

Discharge Level (kV)	Polarity (+/-)	Test Point	Contact Discharge	Air Discharge	Performance Criterion
2, 4	+/-	1~4	Note 1	---	A
6	+/-	1~3	Note 1	---	A
6	+/-	4	Note 2	---	B
2, 4, 8	+/-	5~16	---	Note 1	A

Description of test points of direct application: Please refer to following page for representative mark only.

Test Results of Indirect Application

Discharge Level (kV)	Polarity (+/-)	Test Point	Horizontal Coupling Plane	Vertical Coupling Plane	Performance Criterion
2, 4, 6	+/-	Four Side	Note 1	Note 1	A

Description of test points of indirect application:

1. Front side
2. Rear side
3. Right side
4. Left side

Note: 1. The EUT is operated normal during the test.
 2. The output monitor's panel have flicker during the test, but self-recover after test.

Description of Test Points

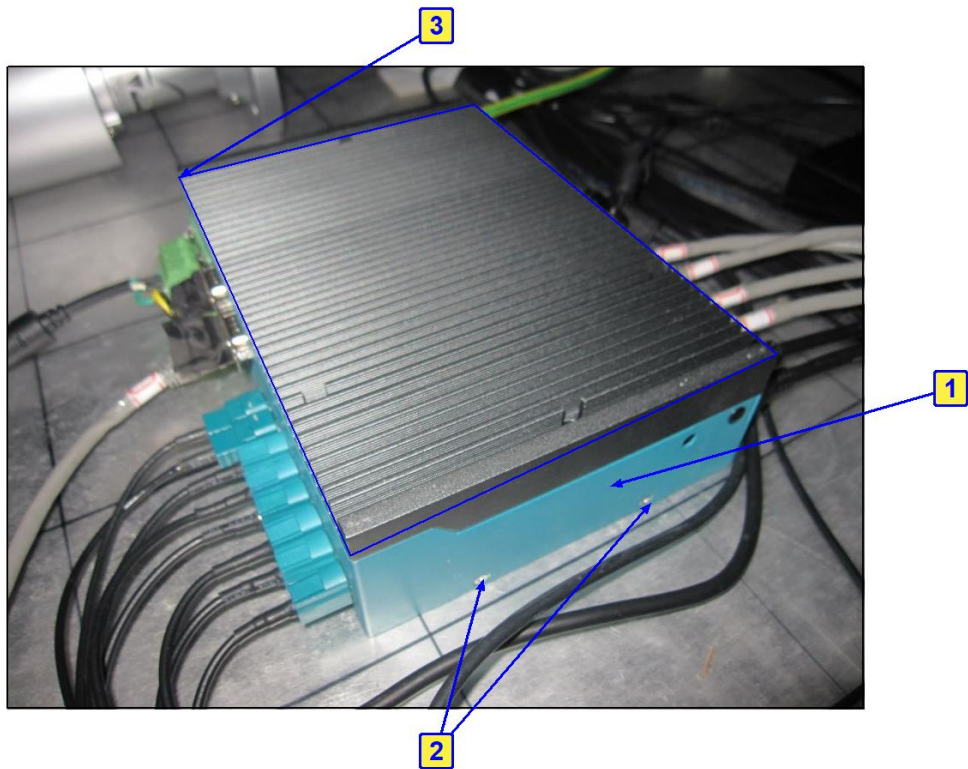

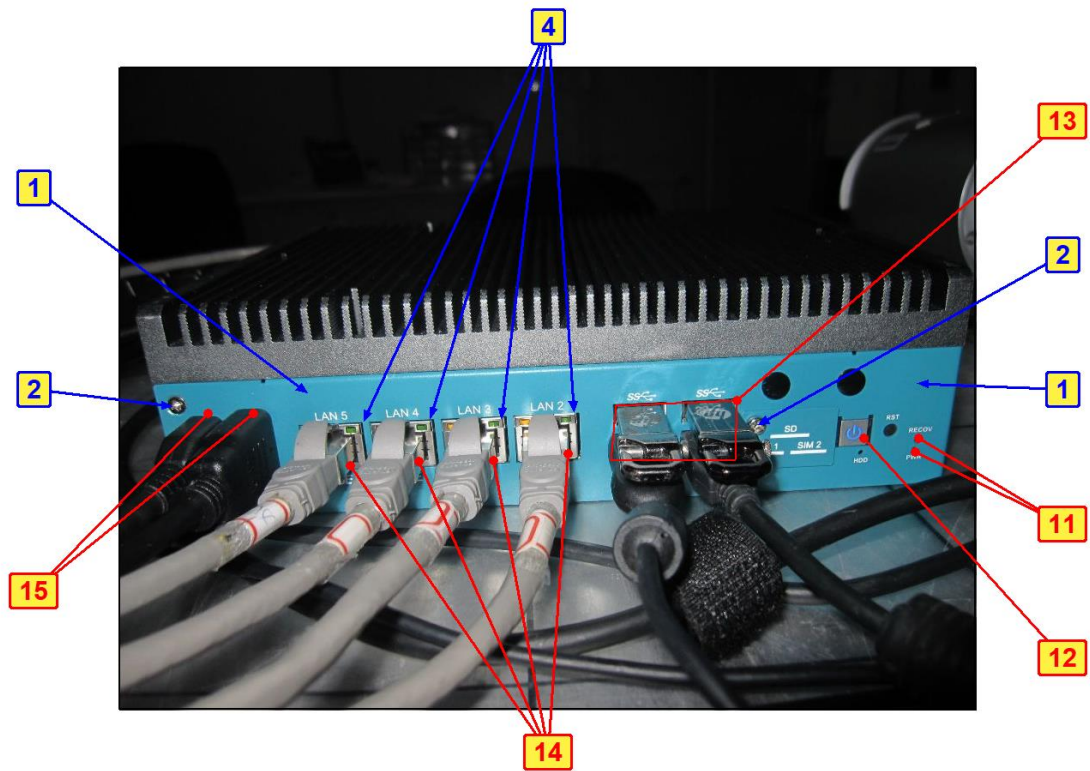
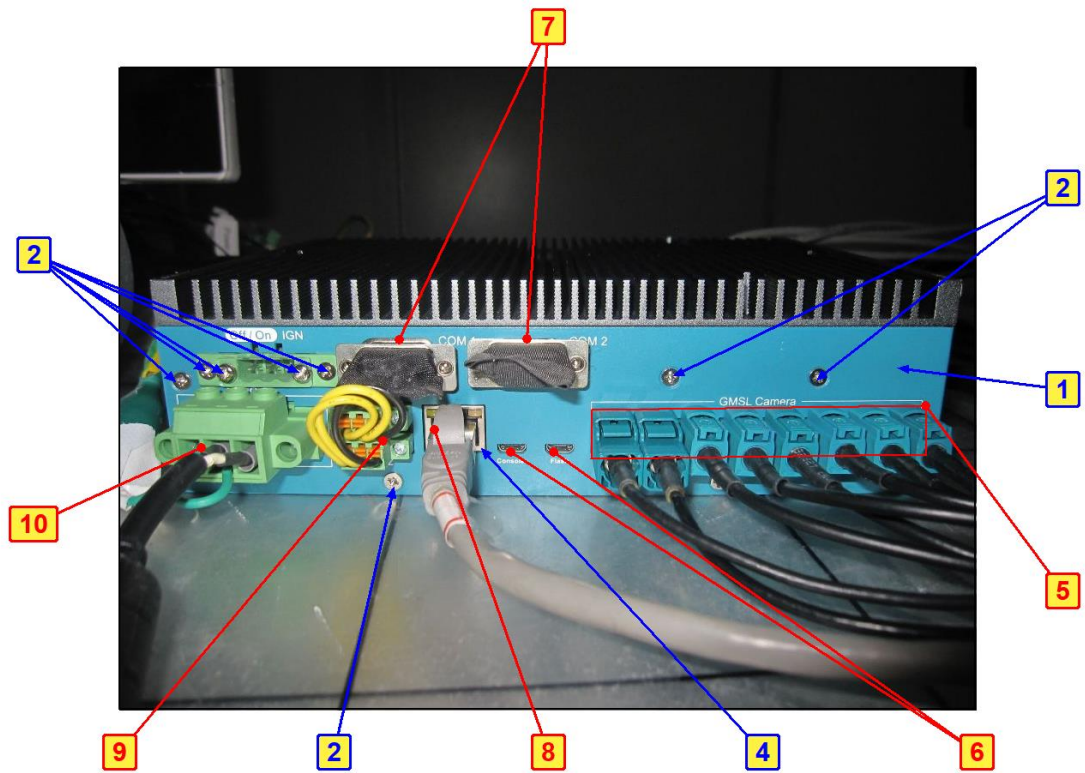

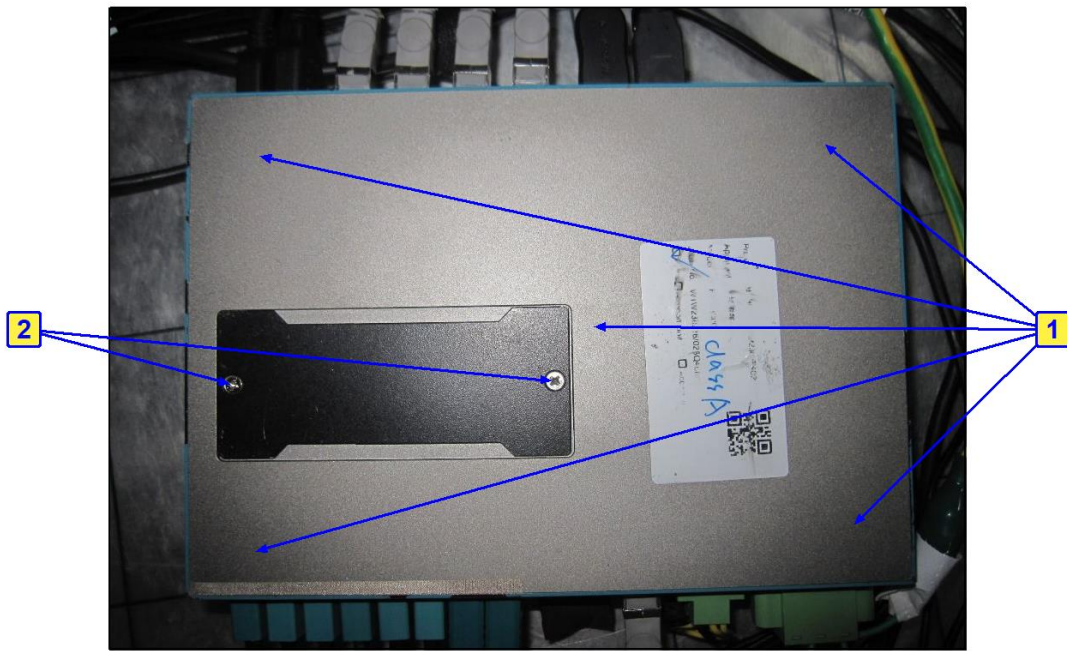

11 Radio-frequency Electromagnetic Field Immunity Test (RS)

11.1 Test Specification

Basic Standard:	EN 61000-4-3
Frequency Range, Field Strength:	80-800 MHz, 20V/m ¹
	800-1000 MHz, 20V/m
	1400-2000 MHz, 10V/m
	2000-2700 MHz, 5V/m
Modulation:	5100-6000 MHz, 3V/m
	1kHz Sine Wave, 80%, AM Modulation
Frequency Step:	1 % of preceding frequency value
Polarity of Antenna:	Horizontal and Vertical
Antenna Height:	1.5m
Dwell Time:	3 seconds

Note 1: This limit applies to equipment mounted in the passenger compartments, drivers cab or external to the rolling stock (roof, underframe). For equipment mounted in all other areas a severity level of 10 V/m may be used.

11.2 Test Instruments

Description Manufacturer	Model No.	Serial No.	Calibrated Date	Calibrated Until
* Broadband Field Meter Narda	NBM-550	B-0872	2022/3/18	2024/3/17
Amplifier BONN	BSA 0125-800	1912556	N/A	N/A
Amplifier TESTQ	CBA 1G-275	T44344	N/A	N/A
Audio analyzer R&S	UPV	104565	2022/5/10	2023/5/9
Band pass filter B&K	WH3278	N/A	2022/6/5	2023/6/4
BiconiLog Antenna EMCO	3141	1001	N/A	N/A
CHANCE MOST Full Anechoic Chamber (9x5x3m)	Chance Most	RS-002	2023/2/3	2024/2/2
Controller AR	SC1000M3	305910	N/A	N/A
Ear Simulator Telephonometry B&K	4185	2553594	N/A	N/A
High Gain Horn Antenna AR	AT4010	0329800	N/A	N/A
LOG ANTENNA Schwarzbeck	Schwarzbeck Stlp 9149	9149-260	N/A	N/A
Log-Periodic Antenna AR	AT6080	0329465	N/A	N/A
Power Amplifier AR	35S4G8AM4	0326094	N/A	N/A
	100S1G4M3	0329249	N/A	N/A

Description Manufacturer	Model No.	Serial No.	Calibrated Date	Calibrated Until
Power Meter BOONTON	4232A	94901	2022/6/6	2023/6/5
Power Sensor BOONTON	51011-EMC	32807	2022/6/6	2023/6/5
		32832	2022/6/6	2023/6/5
Pressure-field Microphone B&K	4192	3190854	2022/12/12	2023/12/11
Signal Generator Agilent	E8257D	MY48050465	2022/6/29	2023/6/28
Software BVADT	RS_V7.6	N/A	N/A	N/A
Software	ABMS_ V7.4.3	N/A	N/A	N/A
Two channel microphone conditioning amplifier B&K	2690 A OS2	2645274	2022/6/5	2023/6/4
Wireless Connection Tester R&S	CMW270	101075	2022/4/18	2023/4/17

Notes:

1. The calibration interval of the above test instruments is 12 months and the calibrations are traceable to NML/ROC and NIST/USA.
2. * The calibration interval of the above test instruments is 24 months and the calibrations are traceable to NML/ROC and NIST/USA
3. The test was performed in Linkou RS Room No.02.
4. Tested Date: 2023/3/17

11.3 Test Arrangement

The test procedure was in accordance with EN 61000-4-3.

- The testing was performed in a fully anechoic chamber.
- The frequency ranges and field strength levels are 80-800 MHz, 20V/m, 800-1000 MHz, 20V/m, 1400-2000 MHz, 10V/m, 2000-2700 MHz, 5V/m and 5100-6000 MHz, 3V/m with the signal 80% amplitude modulated with a 1kHz sine wave.
- The test was performed with the EUT exposed to both vertically and horizontally polarized fields on each of the four sides.

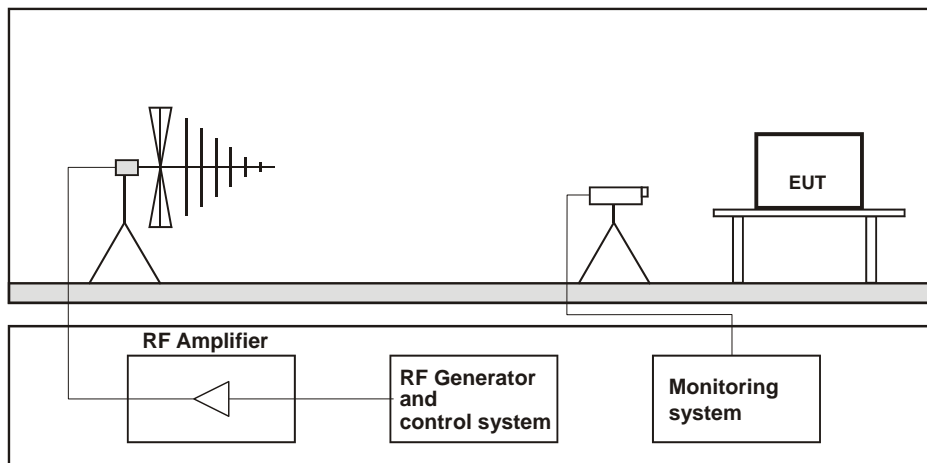

Table-top Equipment

The EUT installed in a representative system as described in section 7 of EN 61000-4-3 was placed on a non-conductive table 0.8 meters in height. The system under test was connected to the power and signal wire according to relevant installation instructions.

For the actual test configuration, please refer to the related item – Photographs of the Test Configuration.

11.4 Test Results

Mode A

Input Power	230Vac, 50 Hz	Tested by	Todd Chang
Environmental Conditions	21 °C, 73 % RH		

Frequency (MHz)	Polarity	Azimuth(°)	Applied Field Strength		Observation	Performance Criterion
			(V/m)	Modulation		
80 - 800	V&H	0, 90, 180, 270	20	80% AM (1kHz)	Note	A
800 - 1000	V&H	0, 90, 180, 270	20	80% AM (1kHz)	Note	A
1400 - 2000	V&H	0, 90, 180, 270	10	80% AM (1kHz)	Note	A
2000 - 2700	V&H	0, 90, 180, 270	5	80% AM (1kHz)	Note	A
5100 - 6000	V&H	0, 90, 180, 270	3	80% AM (1kHz)	Note	A

Note: The EUT is operated normal during the test.

12 Electrical Fast Transient/Burst Immunity Test (EFT)

12.1 Test Specification

Basic Standard:	EN 61000-4-4
Test Voltage:	Signal & communication, process measurement & control ports: $\pm 2\text{kV}$, Capacitive clamp Battery referenced ports (except at the output of energy sources), Auxiliary a.c. power input ports (rated voltage $\leq 400\text{ Vrms}$): $\pm 2\text{kV}$
Impulse Repetition Frequency:	5kHz
Impulse Wave Shape:	5/50 (T_r/T_h) ns
Burst Duration:	15 ms
Burst Period:	300 ms
Test Duration:	1 min.

12.2 Test Instruments

Description Manufacturer	Model No.	Serial No.	Calibrated Date	Calibrated Until
Burst generator Haefely	PEFT 4010	154954	2022/3/29	2023/3/28

Notes:

1. The calibration interval of the above test instruments is 12 months and the calibrations are traceable to NML/ROC and NIST/USA.
2. The test was performed in Linkou EFT Room.
3. Tested Date: 2023/3/21

12.3 Test Arrangement

- Both positive and negative polarity discharges were applied.
- The distance between any coupling devices and the EUT should be 0.5 m for table-top equipment testing, and 1.0 m for floor standing equipment.
- The duration time of each test sequential was 1 minute.
- The transient/burst waveform was in accordance with EN 61000-4-4, 5/50 ns.

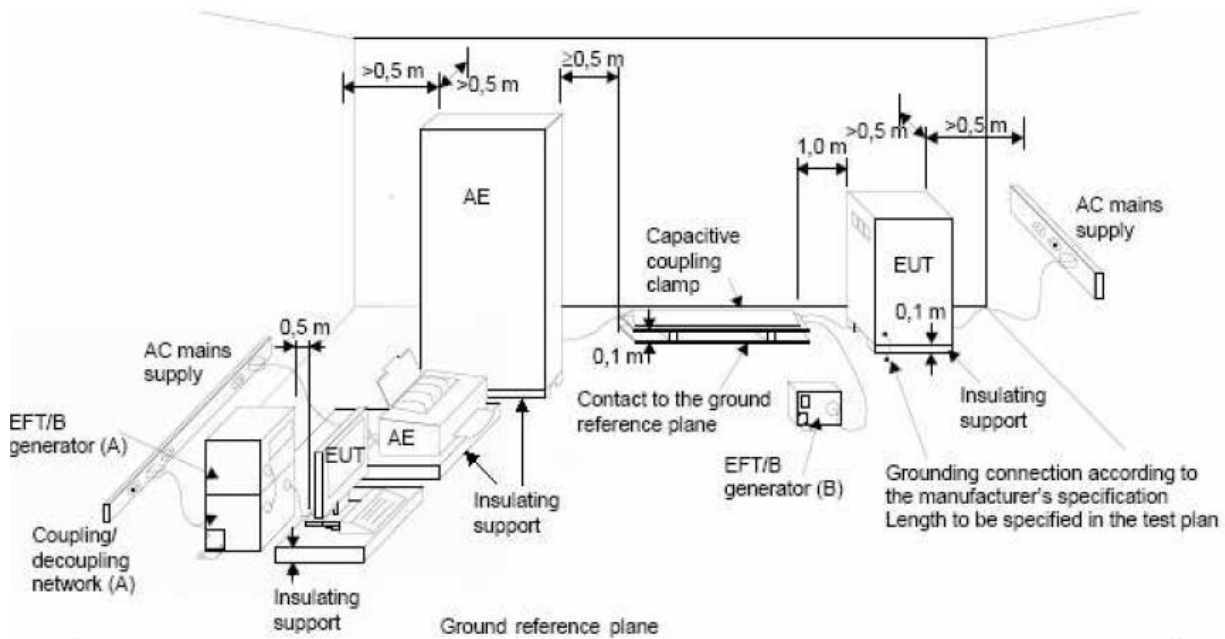

NOTE:

- location for supply line coupling
- location for signal lines coupling

For the actual test configuration, please refer to the related item – Photographs of the Test Configuration.

12.4 Test Results

Mode A

Input Power	230Vac, 50 Hz	Tested by	Chiming Li
Environmental Conditions	21 °C, 69 % RH		

Battery referenced ports (except at the output of energy sources),
 Auxiliary a.c. power input ports (rated voltage ≤ 400 Vrms)

Voltage (kV)	Test Point	Polarity (+/-)	Observation	Performance Criterion
2	L	+/-	Note	A
2	N	+/-	Note	A
2	PE	+/-	Note	A
2	L-N-PE	+/-	Note	A

Signal & communication, process measurement & control ports

Voltage (kV)	Test Point	Polarity (+/-)	Observation	Performance Criterion
2	Shielded LAN	+/-	Note	A
2	Shielded POE LAN	+/-	Note	A
2	CCD(GMSL1)	+/-	Note	A

Note: The EUT is operated normal during the test.

13 Surge Immunity Test

13.1 Test Specification

Basic Standard:	EN 61000-4-5
Wave-Shape:	Battery referenced ports (except at the output of energy sources), Auxiliary a.c. power input ports (rated voltage ≤ 400 Vrms): 1.2/50 μ s Open Circuit Voltage 8/20 μ s Short Circuit Current
Test Voltage:	Line to line: ± 0.5 kV, ± 1 kV, Line to ground: ± 0.5 kV, ± 1 kV, ± 2 kV output impedance of 42 Ω (40 Ω and 2 Ω generator) and a coupling capacitance of 0,5 μ F
AC Phase Angle (degree):	0°, 90°, 180°, 270°
Pulse Repetition Rate:	1 time / 20 sec.
Number of Tests:	5 positive and 5 negative at selected points

13.2 Test Instruments

Description Manufacturer	Model No.	Serial No.	Calibrated Date	Calibrated Until
CDN for Unshielded Unsymmetrical Signal & Data Lines TESEQ	CDN117	40144	2022/8/23	2023/8/22
Coupling Decoupling Network EMC-Partner	CDN-UTP8	045	2022/8/2	2023/8/1
Coupling Decoupling Network TESEQ	CDN HSS-2	41009	2022/4/18	2023/4/17
Surge Coupling Decoupling Network TESEQ	CDN 118-T8	40386	2022/8/23	2023/8/22
Surge&EFT Generators TESEQ	NSG 3060	1572	2022/4/18	2023/4/17

Notes:

1. The calibration interval of the above test instruments is 12 months and the calibrations are traceable to NML/ROC and NIST/USA.
2. The test was performed in Linkou EMS Room No.02.
3. Tested Date: 2023/3/17

13.3 Test Arrangement

The surge is to be applied to the EUT power supply terminals via the capacitive coupling network. Decoupling networks are required in order to avoid possible adverse effects on equipment not under test that may be powered by the same lines, and to provide sufficient decoupling impedance to the surge wave. The power cord between the EUT and the coupling/decoupling networks shall be 2 meters in length (or shorter).

For double-insulated products without PE or external earth connections, the test shall be done in a similar way as for grounded products but without adding any additional external grounded connections. If there are no other possible connections to earth, line-to-ground tests may be omitted.

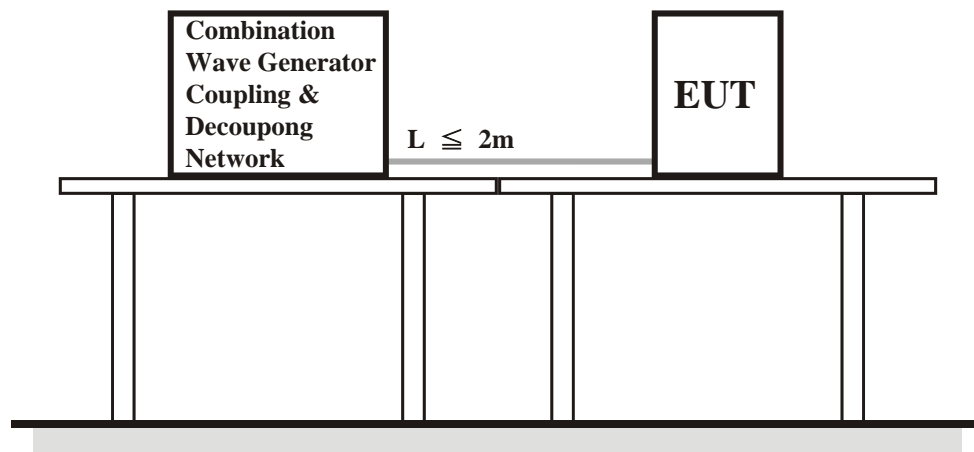

For the actual test configuration, please refer to the related item – Photographs of the Test Configuration.

13.4 Test Results

Mode A

Input Power	230Vac, 50 Hz	Tested by	Sean Chou
Environmental Conditions	21 °C, 71 % RH		

Battery referenced ports (except at the output of energy sources),
 Auxiliary a.c. power input ports (rated voltage ≤ 400 Vrms)

Voltage (kV)	Test Point	Azimuth(°)	Polarity (+/-)	Observation	Performance Criteria
0.5, 1(42 Ω +0.5 μ F)	L-N	0,90,180,270	+/-	Note 1	A
0.5, 1(42 Ω +0.5 μ F)	L-PE	0,90,180,270	+/-	Note 1	A
0.5, 1(42 Ω +0.5 μ F)	N-PE	0,90,180,270	+/-	Note 1	A
0.5, 1, 2(42 Ω +0.5 μ F)	L-PE	0,90,180,270	+/-	Note 2	B
0.5, 1, 2(42 Ω +0.5 μ F)	N-PE	0,90,180,270	+/-	Note 2	B

- Notes: 1. The EUT is operated normal during the test.
 2. The output monitor's panel turn to black during the test, but self-recover after test.

14 Immunity to Conducted Disturbances Induced by RF Fields (CS)

14.1 Test Specification

Basic Standard:	EN 61000-4-6
Frequency Range:	0.15 MHz - 80 MHz
Voltage Level:	Battery referenced ports (except at the output of energy sources), Auxiliary a.c. power input ports (rated voltage \leq 400 Vrms), Signal & communication, process measurement & control ports: 10 V
Modulation:	1kHz Sine Wave, 80%, AM Modulation
Frequency Step:	1 % of preceding frequency value
Dwell Time	3 seconds

14.2 Test Instruments

Description Manufacturer	Model No.	Serial No.	Calibrated Date	Calibrated Until
Audio analyzer R&S	UPV	104565	2022/5/10	2023/5/9
CDN FCC	FCC-801-M5-50A	100018	2023/1/17	2024/1/16
CDN TESEQ	CDN S200	53490	2023/2/23	2024/2/22
	CDN S400	52115	2023/2/23	2024/2/22
CDN Calibration Kit TESEQ	CDN T8S	29459	2023/2/21	2024/2/20
CDN M2-16Amp FCC	FCC-801-M2-16A	01047	2023/2/22	2024/2/21
Coupling Decoupling Network TESEQ	CDN M432S	56519	2023/2/22	2024/2/21
	CDN S751A	56435	2023/2/20	2024/2/19
		56436	2023/2/21	2024/2/20
	CDN ST08A	56525	2023/2/20	2024/2/19
		56527	2023/2/20	2024/2/19
	CDN T2A-10	54942	2023/2/21	2024/2/20
	CDN T8-10	40376	2023/2/21	2024/2/20
	CDN T8-230	56641	2023/2/21	2024/2/20
		56642	2023/2/21	2024/2/20
CDN T800	34428	2023/2/21	2024/2/20	
CDN T400A	49918	2023/2/22	2024/2/21	
Coupling/Dcoupling Network EM TEST	CDN M1/32A	306508	2023/2/22	2024/2/21
Coupling/Dcoupling Network TESEQ	CDN M232	37702	2023/2/22	2024/2/21
	CDN M332	41256	2023/2/22	2024/2/21
		41258	2023/2/22	2024/2/21
CS Power Amplifier ETS-Lindgren	8100-010	00163535	N/A	N/A
Current Clamp FCC	F-120-9A	361	2022/8/17	2023/8/16
Ear Simulator Telephonometry B&K	4185	2553594	N/A	N/A

Description Manufacturer	Model No.	Serial No.	Calibrated Date	Calibrated Until
FCC EM Injection Clamp FCC	F-203I-23mm	455	N/A	N/A
Mouth Simulator B&K	4227	2630632	N/A	N/A
POWER AMPLIFIER B&K	2716C	2610979	N/A	N/A
Power Meter R & S	NRVD	837794/040	2022/10/18	2023/10/17
Power Sensor R & S	NRV-Z5	837878/039	2022/10/18	2023/10/17
Pressure-field Microphone B&K	4192	2735407	N/A	N/A
SIGNAL GENERATOR R&S	SML03	101364	2022/8/16	2023/8/15
Software BVADT	ABMS_ V7.4.3	N/A	N/A	N/A
Software BVADT	BVADT_CS_V7.6.6	N/A	N/A	N/A
Two channel microphone conditioning amplifier B&K	2690 OS2	3001996	2022/11/15	2023/11/14
Wireless Connection Tester R&S	CMW270	101075	N/A	N/A

Notes:

1. The calibration interval of the above test instruments is 12 months and the calibrations are traceable to NML/ROC and NIST/USA.
2. The test was performed in Linkou CS Room No.1.
3. Tested Date: 2023/3/18

14.3 Test Arrangement

- The EUT shall be tested within its intended operating and climatic conditions.
- An artificial hand was placed on the hand-held accessory and connected to the ground reference plane.
- One of the CDNs not used for injection was terminated with 50 ohm, providing only one return path. All other CDNs were coupled as decoupling networks.
- The frequency range is swept from 150 kHz to 80 MHz, using the signal level established during the setting process and with a disturbance signal of 80 % amplitude. The signal is modulated with a 1 kHz sine wave, pausing to adjust the RF signal level or the switch coupling devices as necessary. Where the frequency is swept incrementally, the step size shall not exceed 1 % of the preceding frequency value.
- Attempts should be made to fully exercise the EUT during testing, and to fully interrogate all exercise modes selected for susceptibility.

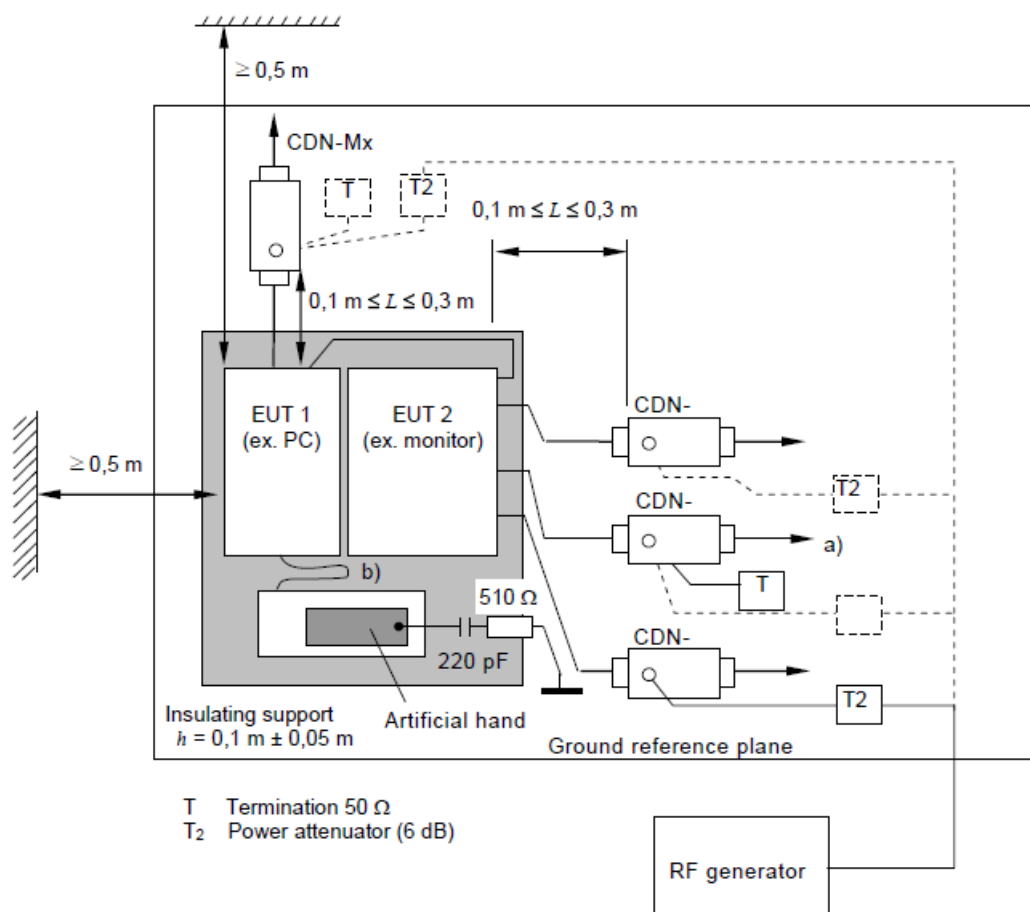

IEC 2606/13

- Note:**
- The EUT clearance from any metallic obstacles shall be at least 0,5 m.
 - Interconnecting cables (≤ 1 m) belonging to the EUT shall remain on the insulating support.
 - The equipment to be tested is placed on an insulating support of 0.1 meters height above a ground reference plane. All relevant cables shall be provided with the appropriate coupling and decoupling devices at a distance between 0.1 meters and 0.3 meters from the projected geometry of the EUT on the ground reference plane.

For the actual test configuration, please refer to the related item – Photographs of the Test Configuration.

14.4 Test Results

Mode A

Input Power	230Vac, 50 Hz	Tested by	Todd Chang
Environmental Conditions	20 °C, 71 % RH		

Input AC power port							
Frequency (MHz)	Level (V rms)	Modulation	Tested Line	Injection Method	Return Path	Observation	Performance Criteria
0.15 – 80	10	80% AM (1kHz)	AC	CDN-M3	CDN-M1	Note	A

Wired network and signal/ control port							
Frequency (MHz)	Level (V rms)	Modulation	Tested Line	Injection Method	Return Path	Observation	Performance Criteria
0.15 – 80	3	80% AM (1kHz)	Shielded LAN	CDN-ST08A	CDN-M1	Note	A
0.15 – 80	3	80% AM (1kHz)	Shielded POE LAN	CDN-ST08A	CDN-M1	Note	A
0.15 – 80	3	80% AM (1kHz)	CCD(GMSL1)	EM-CLAMP	CDN-M1	Note	A

Note: The EUT is operated normal during the test.

15 Pictures of Test Arrangements

15.1 Conducted Disturbance at Auxiliary a.c. or d.c. power ports

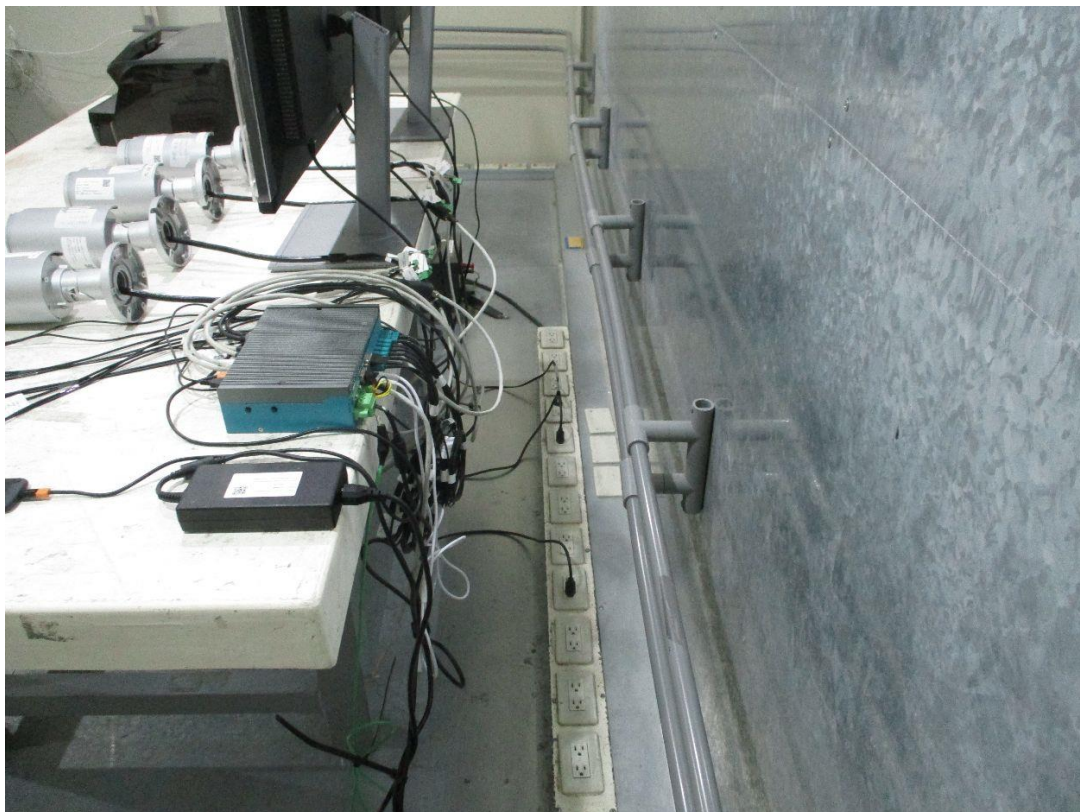

15.2 Radiated Disturbance up to 1 GHz



15.3 Radiated Disturbance above 1 GHz

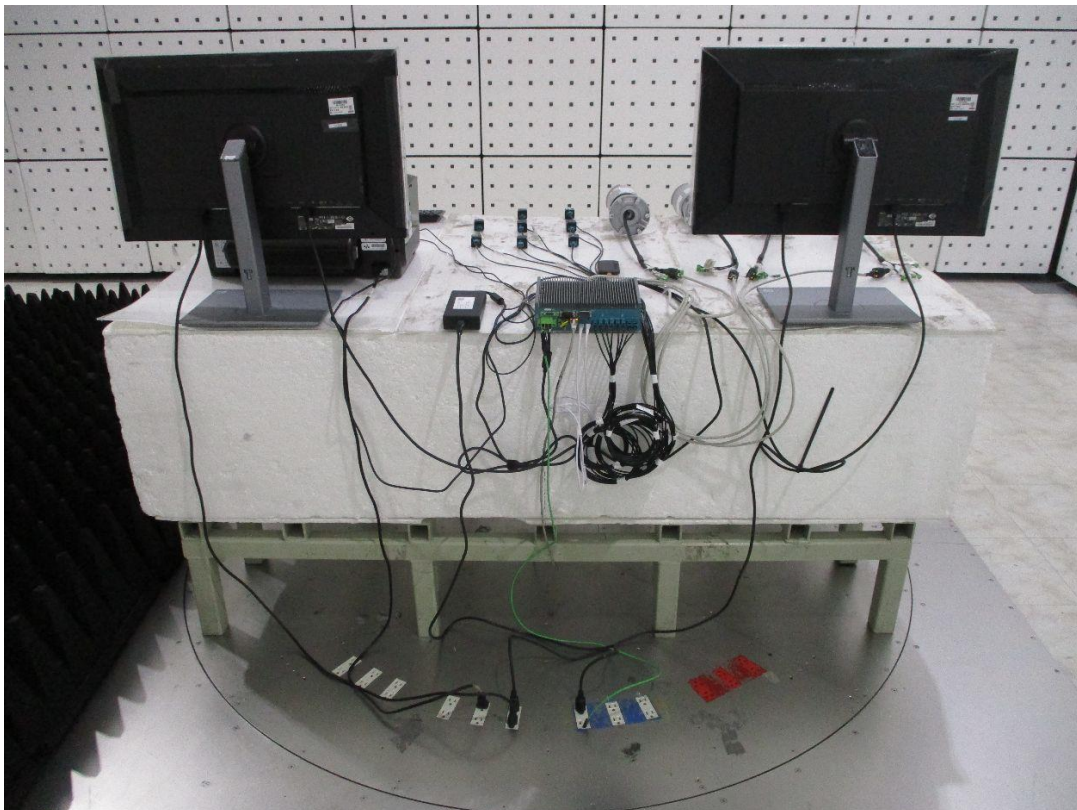

15.4 Harmonics Current, Voltage Fluctuations and Flicker Measurement



15.5 Electrostatic Discharge Immunity Test (ESD)



15.6 Radio-frequency Electromagnetic Field Immunity Test (RS)

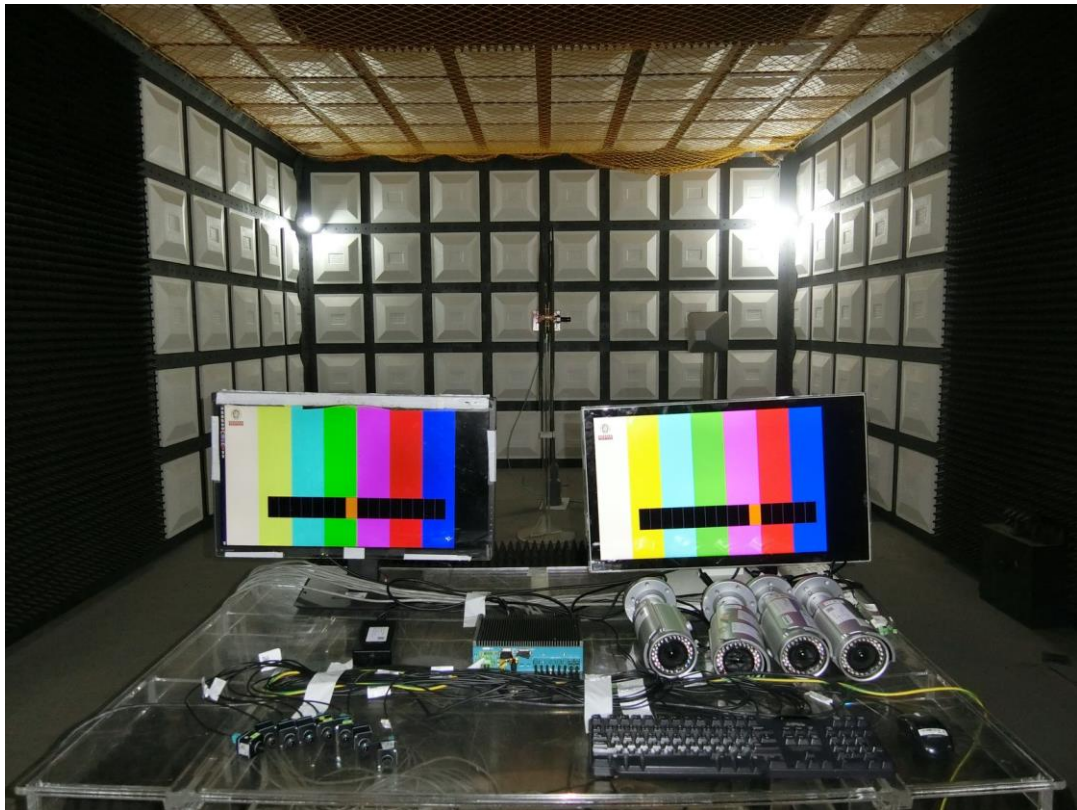

15.7 Fast Transients (EFT)

Mains port



Shielded LAN



Shielded POE LAN



CCD(GMSL1)

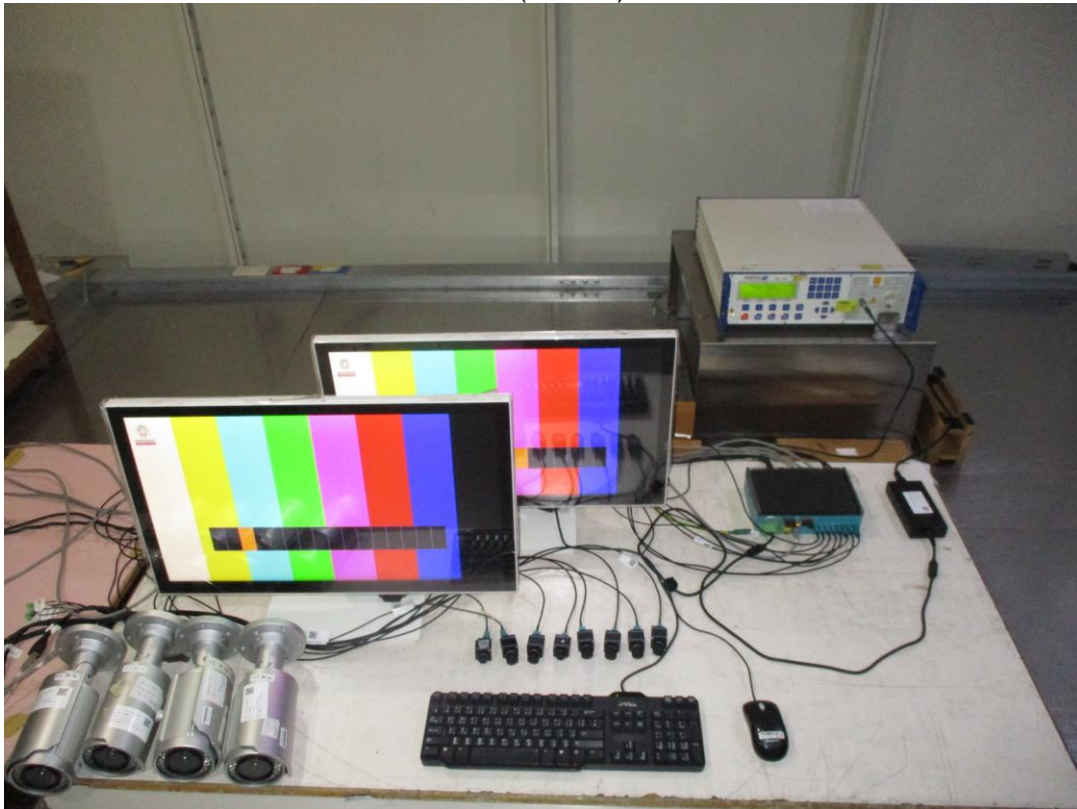

15.8 Surge

Mains ports



15.9 Radio-frequency common mode (CS)

Mains port

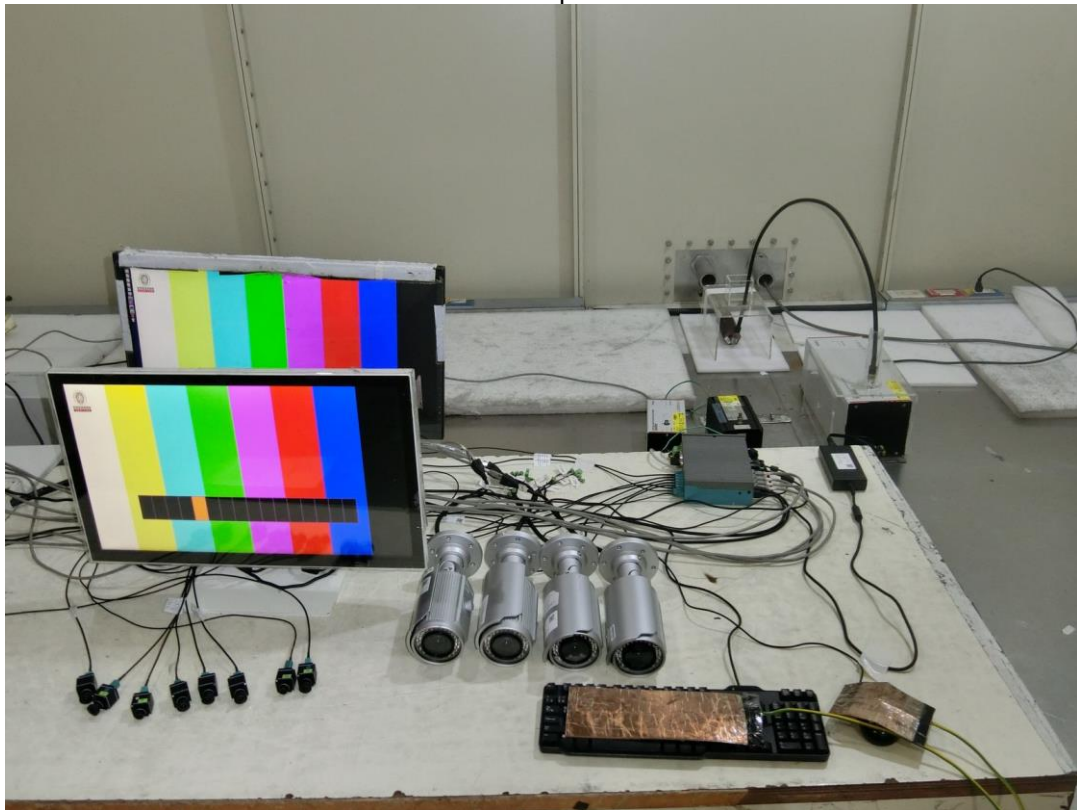

Shielded LAN

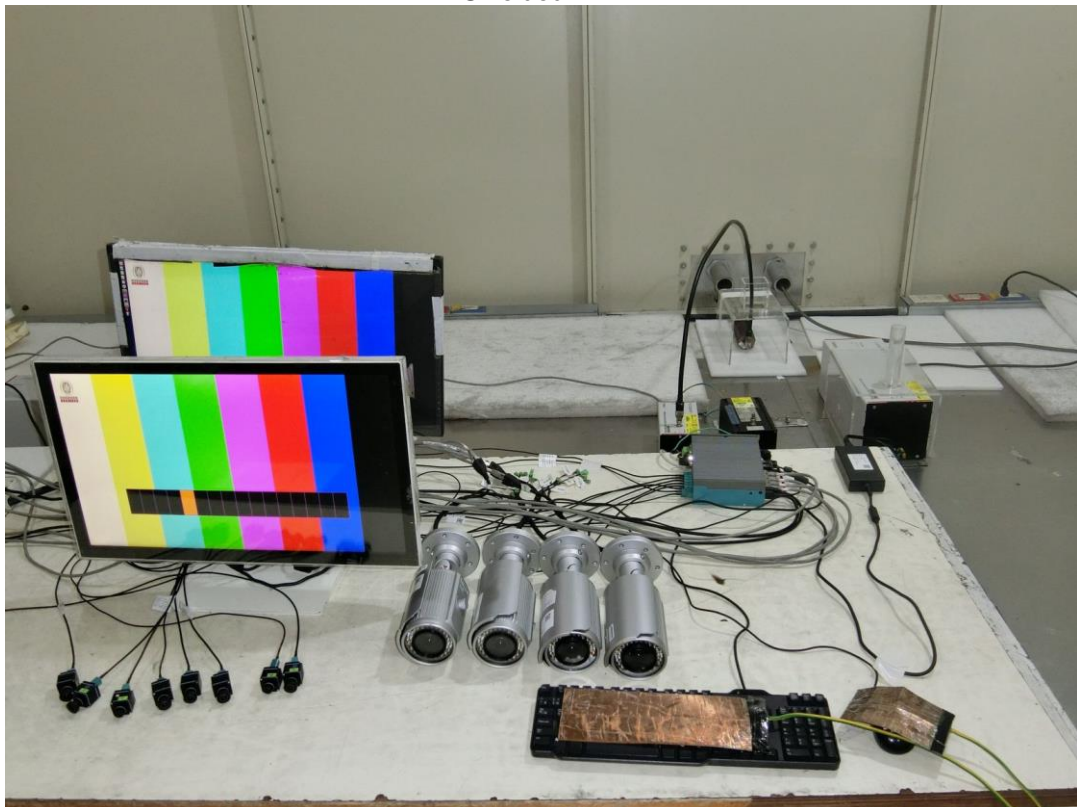

Shielded POE LAN

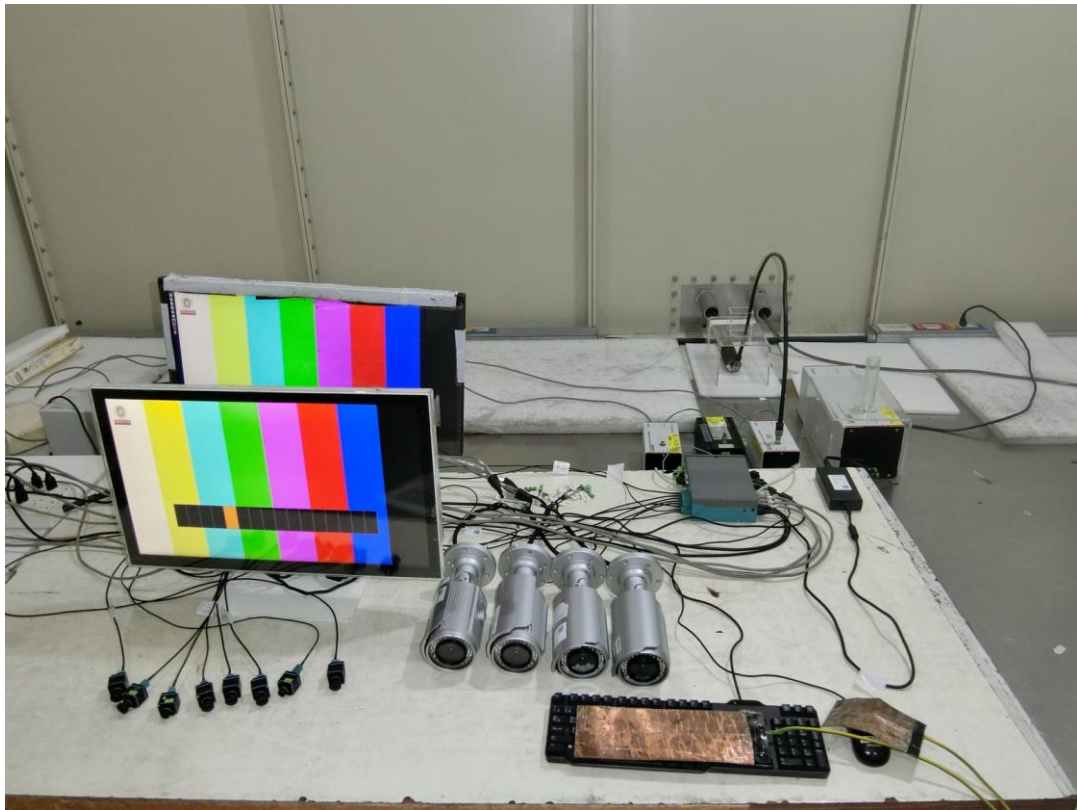

CCD(GMSL1)

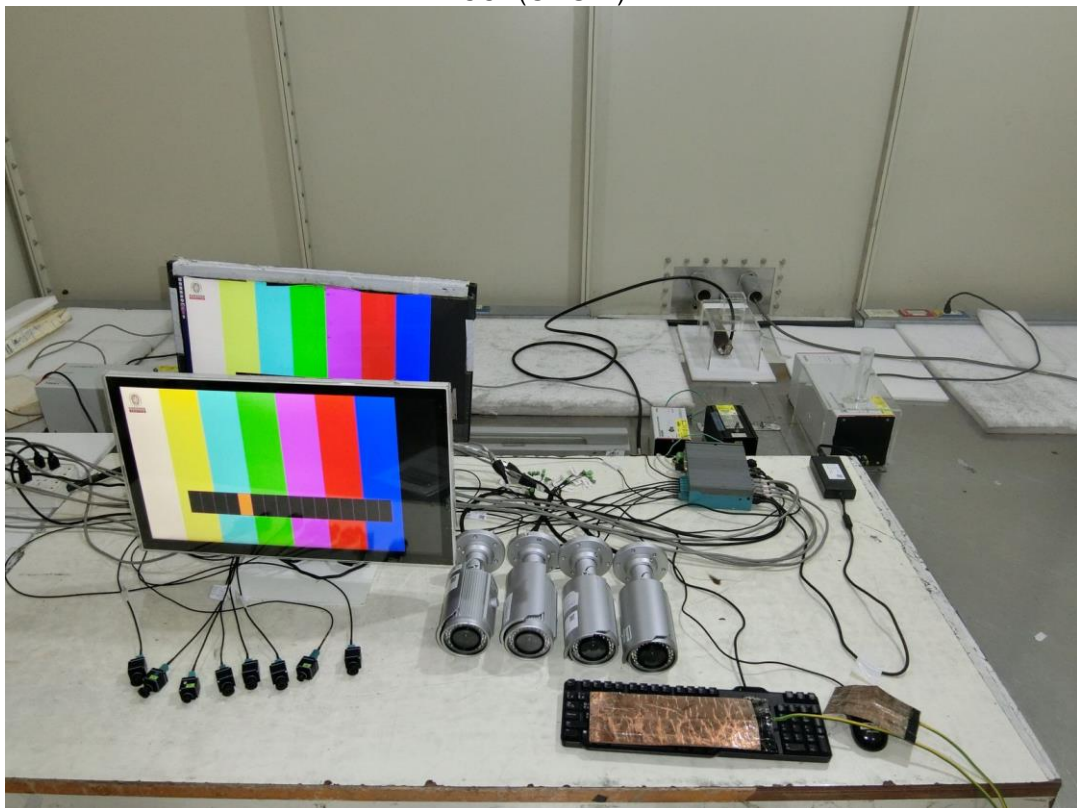

Appendix – Information of the Testing Laboratories

We, Bureau Veritas Consumer Products Services (H.K.) Ltd., Taoyuan Branch, were founded in 1988 to provide our best service in EMC, Radio, Telecom and Safety consultation. Our laboratories are accredited and approved according to ISO/IEC 17025.

If you have any comments, please feel free to contact us at the following:

Lin Kou EMC/RF Lab

Tel: 886-2-26052180

Fax: 886-2-26051924

Hsin Chu EMC/RF/Telecom Lab

Tel: 886-3-6668565

Fax: 886-3-6668323

Hwa Ya EMC/RF/Safety Lab

Tel: 886-3-3183232

Fax: 886-3-3270892

Email: service.adt@bureauveritas.com

Web Site: <http://ee.bureauveritas.com.tw>

The address and road map of all our labs can be found in our web site also.

--- END ---